



Gaskets

Oven doors
Dishwasher doors
Laundry machines
O-Ring Gaskets



Porta forno
Oven doors
Ofentir
Puerta horno



Porta lavastoviglie
Dishwasher doors
Spülmaschine
Puerta lavavajilla



Lavabiancheria
Laundry machines
Waschmaschinen
Lavadoras



Guarnizioni O-Ring
O-Ring Gaskets
O-Ring Dichtungen
Juntas O-Ring



Leading European distributor of **spare parts** of **original quality**

Full transparency...
by **LF** you know what you buy



Cooking equipment

14,317 items

- Cooking equipment
- Ovens
- Pizza ovens
- Microwave ovens
- Food processing equipment



Washing and laundry equipment

11,023 items

- Warewashing equipment
- Laundry machines
- Ironing equipment
- Commercial faucets



Coffee and vending equipment

12,647 items

- Espresso machines
- Superautomatic machines
- Filter coffee machines
- Coffee grinders
- Vending equipment
- Barista tools
- Bar equipment



Refrigeration equipment

5,259 items

- Commercial refrigeration
- Blast chillers
- Ice makers
- Dispensing equipment

Sommario
Contents
Inhaltsverzeichnis
Índice



p. 5 Guarnizioni per porta forno
Oven door gaskets
Dichtungen für Ofentür
Burletes puerta horno



p. 35 Guarnizioni porta lavastoviglie
Door gaskets for dishwashers
Türdichtungen für Spülmaschine
Burletes puerta lavavajilla



p. 45 Guarnizioni per lavabiancheria
Gaskets for laundry machines
Dichtungen für Waschmaschinen
Juntas para lavadoras



p. 56 Guarnizioni OR
O-Ring Gaskets
O-Ring Dichtungen
Juntas O-Ring



The most powerful search engine
to order **gaskets** for refrigeration **online**

Gaskets for commercial refrigeration
The largest offer & catalogue of the branch

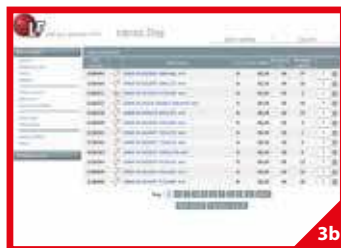

www.lfspareparts724.com



Guarnizioni di produzione e qualità industriale



Gaskets of industrial production quality

Dichtungen industrieller Produktion und Qualität

Burletes de producción y calidad industrial



1

- Angolo rinforzato con utensile speciale**
- Corner reinforced using a special tool
- Verstärkte Ecken durch Spezialwerkzeug
- Angulo reforzado con utensilio especial

2

- Foro evacuazione aria per maggior tenuta**
- Air exhaust hole for better sealing
- Luftausgleichsloch für bessere Abdichtung
- Agujero de salida aire para mayor estanqueidad

Vasto programma in pronta consegna

Large program ready from stock

Ein großes Sortiment lagerbereit

Amplio programa listo para la entrega



www.lfspareparts724.com

Guarnizioni per porta forno

Oven door gaskets

Dichtungen für Ofentür

Burletes puerta horno



Ricambi in qualità originale

Spare parts of original quality

Ersatzteile in Originalqualität

Repuestos en calidad original



Adattabili per tutti i migliori marchi

Suitable for all the major brands

Passend für die bekanntesten Hersteller

Suitable for the best brands

Alpeninox
Alphatec
Alto-Shaam
Angelo Po
Bonnet
Bourgeois
Convothem

Coven
Electrolux
Eloma
Erre 2
Foemm
Frima
Garbin

Gayc
Gemini Forni
Gierre
Giga
Hobart
Juno-Röder-Senking
Kelvin

Metos
Mkn
Morice
Palux
Rational
Repagas
Roller Grill

Rosinox
Sammic
Smeg
Sogeco
Tecnoeka
Thirode
Unox

Voss
Whirlpool
Zanussi

Guarnizioni per porta forno
Oven door gaskets
Dichtungen für Ofentür
Burletes puerta horno

Profilo . Profile . Profil . Perfil

5001

In elastomero siliconico . Silicone elastomer
Silikonelastomer . Elastomero de silicona

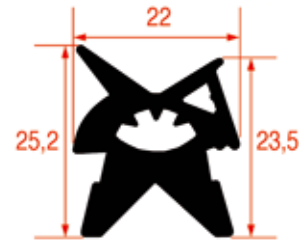

LF Code	Dimensions	Suitable ANGELO PO
3186359	410x320 mm	37Q1002
3786096	410x330 mm	37Q4980
3186361	460x450 mm	37Q0952
3186365	680x570 mm	37Q0982
3186363	700x445 mm	37Q0972
3186367	850x660 mm	37Q0992
3186430	1395x680 mm	37Q7633

Profilo . Profile . Profil . Perfil

5002

In elastomero siliconico . Silicone elastomer
Silikonelastomer . Elastomero de silicona



LF Code	Dimensions	Suitable ALTO-SHAAM	Suitable CONVOTHERM
3786615	510x465 mm		7011001
3786726	560x425 mm	GS-26635	
3786730	625x560 mm	GS-26639	
3786729	725x620 mm	GS-26638	
3186533	775x465 mm		7011002
3186540	780x670 mm		7011005
3186534	970x670 mm		7011006
3186536	1500x470 mm		7011003
3186535	1500x670 mm		7011007
3786732	1540x700 mm	GS-26641	

Profilo . Profile . Profil . Perfil

5003

In elastomero siliconico . Silicone elastomer
Silikonelastomer . Elastomero de silicona

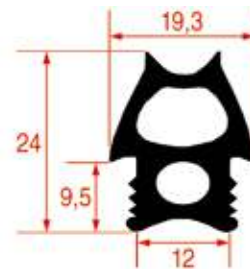

LF Code	Dimensions	Suitable ANGELO PO
3786097	485x485 mm	36E3031
3786099	685x630 mm	36E4061
3786098	695x485 mm	36E3021
3786100	855x685 mm	36E3521
3786599	1365x485 mm	3050160
3786597	1380x688 mm	36E3921

Profilo . Profile . Profil . Perfil

5004

In elastomero siliconico . Silicone elastomer
Silikonelastomer . Elastomero de silicona

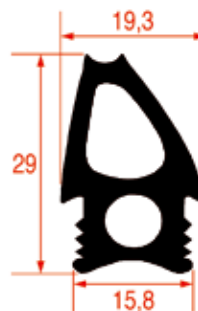

LF Code	Dimensions	Suitable ANGELO PO
7102053	475x470 mm	3077261
5057446	690x630 mm	3077291
5051484	1405x470 mm	3077281
5056338	1410x690 mm	3077311

Profilo . Profile . Profil . Perfil

5005

In elastomero siliconico . Silicone elastomer
Silikonelastomer . Elastomero de silicona



LF Code	Dimensions	Suitable ALTO-SHAAM	Suitable FAGOR	Suitable RATIONAL
3786728	725x430 mm	GS-26637		
3786731	1030x700 mm	GS-26640		
3786021	1475x475 mm		RT2000398P	2000398P
3786022	1475x670 mm		RT2000399P	2000399P

Profilo . Profile . Profil . Perfil

5006

In elastomero siliconico . Silicone elastomer
Silikonelastomer . Elastomero de silicona

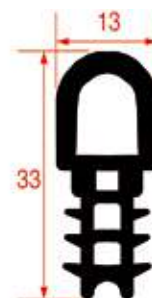

LF Code	Dimensions	Suitable CONVOTHERM	Suitable MKN	Suitable MORICE
3786320	620x464 mm			DM1065
3186388	625x485 mm	7001016	7001016	
3786321	724x620 mm			DM1066
3186389	725x625 mm	7001017	7001017	
3786023	760x670 mm	7001050		
3786024	808x635 mm	7001032		
3186391	1065x700 mm - 3 sides	7001020	7001020	
3186390	1650x700 mm - 3 sides	7001018	7001018	
3286080	3 m	7001013	7001013	
3286015	6 m	7001013	7001013	
3286016	25 m	7001013	7001013	
5039568	1480x605 mm		211096	

Guarnizioni per porta forno
Oven door gaskets
Dichtungen für Ofentür
Burletes puerta horno

Profilo . Profile . Profil . Perfil

5007

In elastomero siliconico . Silicone elastomer
Silikonelastomer . Elastomero de silicona



LF Code	Dimensions	Suitable ALPENINOX	Suitable EMMEPI	Suitable FAGOR	Suitable RATIONAL	Suitable ELECTROLUX/ZANUSSI
3186478	500x480 mm	0C1496				0C1496
3186319	530x473 mm		809657	RT51051020	51051020P	
3786120	755x660 mm	0C1887				0C1887
3186483	760x485 mm	0C1477				0C1477
3786020	770x680 mm			RT2000397P	2000397P	
3186426	780x470 mm		809562	RT51051021	51051021P	
3786015	807x690 mm			RT51051022P	51051022P	
3186480	1470x480 mm	0C1473				0C1473
3786121	1475x660 mm	0C1889				0C1889
3186481	1500x490 mm			RT51051023P	51051023P	
3786016	1505x695 mm			RT51051024P	51051024P	

Profilo . Profile . Profil . Perfil

5008

In elastomero siliconico . Silicone elastomer
Silikonelastomer . Elastomero de silicona

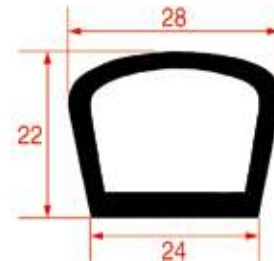

LF Code	Dimensions	Suitable CAPIC	Suitable MORICE
3786301	645x510 mm		DM0566
3786305	SOLD PER METER	I304016	

Profilo . Profile . Profil . Perfil

5009

In elastomero siliconico . Silicone elastomer
Silikonelastomer . Elastomero de silicona

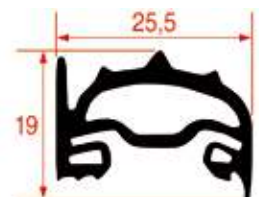

LF Code	Dimensions	Suitable MBM	Suitable OLIS
3186400	530x450 mm		3108600
3186417	630x480 mm	RTFOC00723	
3186419	690x480 mm	RTFOC00721	
3186418	730x680 mm	RTFOC00722	
3186375	770x450 mm		3108700
3186395	770x635 mm		3108800
5016087	1460x445 mm		3108820

Guarnizioni per porta forno
Oven door gaskets
Dichtungen für Ofentür
Burletes puerta horno

Profilo . Profile . Profil . Perfil

5010

In elastomero siliconico . Silicone elastomer
Silikonelastomer . Elastomero de silicona

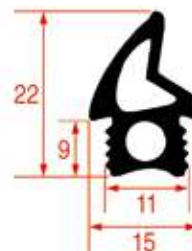

LF Code	Dimensions	Suitable BAKE OFF	Suitable FOINOX
3786621	2200 mm		60320
3786595	6400 mm	331800015	

Profilo . Profile . Profil . Perfil

5011

In elastomero siliconico . Silicone elastomer
Silikonelastomer . Elastomero de silicona



LF Code	Dimensions	Suitable ELOMA/PALUX
5020135	640x460 mm	384410
5017638	700x650 mm	382310

Profilo . Profile . Profil . Perfil

5012

In elastomero siliconico . Silicone elastomer
Silikonelastomer . Elastomero de silicona

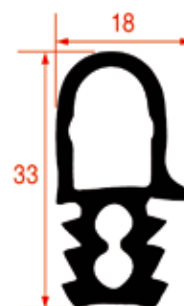

LF Code	Dimensions	Suitable ELOMA	Suitable PALUX
3186524	520x490 mm	742368	742368
3186527	765x510 mm	742376	
3186528	1495x510 mm	742384	

Guarnizioni per porta forno
Oven door gaskets
Dichtungen für Ofentür
Burletes puerta horno

Profilo . Profile . Profil . Perfil

5013

In elastomero siliconico . Silicone elastomer
Silikonelastomer . Elastomero de silicona

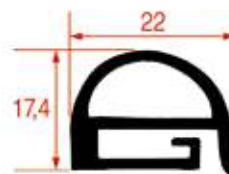

LF Code	Dimensions	Suitable FAGOR
3186321	650x470 mm	R660503000
3186322	700x650 mm	R670500000
3186323	775x700 mm	R680500000
5032423	1300x760 mm	R140506000

Profilo . Profile . Profil . Perfil

5014 Standard

In elastomero siliconico . Silicone elastomer
Silikonelastomer . Elastomero de silicona



LF Code	Dimensions	Suitable FAGOR	Suitable RATIONAL
3786674	500x470 mm	RT2001800P	2001800P
3786675	680x500 mm		2001801P
3786676	760x470 mm	RT2001802P	2001802P
3786677	760x675 mm		2001803P

Profilo . Profile . Profil . Perfil

5014/1 Superflex

In elastomero siliconico . Silicone elastomer
Silikonelastomer . Elastomero de silicona

Additivo speciale per maggior flessibilità e tenuta
Special additive for greater flexibility and sealing power
Ein spezielles Additiv für höhere Flexibilität und längere Dichtheit
Aditivo especial para mayor flexibilidad y resistencia

Maggiore resistenza ai detersivi
More resistant to detergent
Höhere Beständigkeit gegen Reinigungsmittel
Mayor resistencia a los detergentes

Maggiore resistenza ai grassi e agli oli saturi
More resistant to grease and saturated oils.
Höhere Beständigkeit gegen Fette und gesättigte Öle
Mayor resistencia a las grasas y a los aceites saturados



LF Code	Dimensions	Suitable FAGOR	Suitable RATIONAL
3586001	500x470 mm	RT2001800P	2001800P
3586002	760x470 mm	RT2001802P	2001802P

Profilo . Profile . Profil . Perfil

5015

In elastomero siliconico . Silicone elastomer
Silikonelastomer . Elastomero de silicona

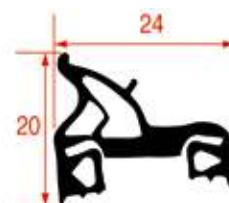

LF Code	Dimensions	Suitable ALPENINOX	Suitable JUNO	Suitable ZANUSSI
3786126	610x430 mm	005707	237390	005707
3186408	635x430 mm	005713		005713
3786125	720x640 mm	005706		005706
3186088	730x665 mm	005712	237387	005712
3186410	1400x640 mm	005705	237389	005705
3186425	1400x650 mm	005711		005711

Profilo . Profile . Profil . Perfil

5016

In elastomero siliconico . Silicone elastomer
Silikonelastomer . Elastomero de silicona

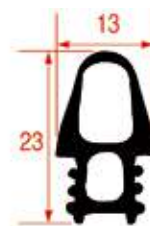

LF Code	Dimensions	Suitable ALPENINOX	Suitable ZANUSSI
3186386	620x414 mm	0H6653	0H6653
3186385	699x620 mm	0H6656	0H6656

Profilo . Profile . Profil . Perfil

5017

In elastomero siliconico . Silicone elastomer
Silikonelastomer . Elastomero de silicona

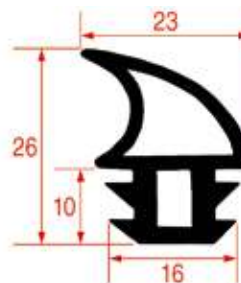

LF Code	Dimensions	Suitable FOINOX
3786112	650x515 mm	14080
3786113	775x660 mm	14081

Profilo . Profile . Profil . Perfil

5018

In elastomero siliconico . Silicone elastomer
Silikonelastomer . Elastomero de silicona

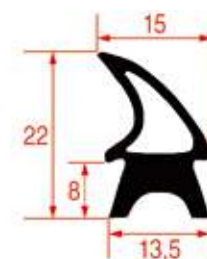

LF Code	Dimensions	Suitable GIERRE
3186151	640x460 mm	XXGUA500
3186512	865x645 mm	GUA510

Profilo . Profile . Profil . Perfil

5019

In elastomero siliconico . Silicone elastomer
Silikonelastomer . Elastomero de silicona

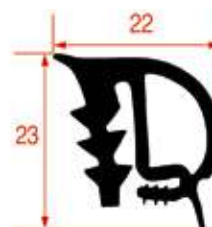

LF Code	Dimensions	Suitable RATIONAL
3786243	520x470 mm	51051001
3186427	785x470 mm	51051004

Guarnizioni per porta forno
Oven door gaskets
Dichtungen für Ofentür
Burletes puerta horno

Profilo . Profile . Profil . Perfil

5020

In elastomero siliconico . Silicone elastomer
Silikonelastomer . Elastomero de silicona

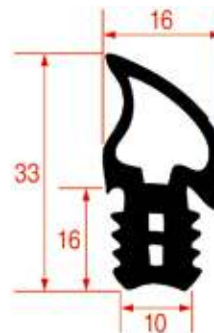

LF Code	Dimensions	Suitable MKN
3186562	605x475 mm	211094
3186563	745x605 mm	211095

Profilo . Profile . Profil . Perfil

5021

In elastomero siliconico . Silicone elastomer
Silikonelastomer . Elastomero de silicona

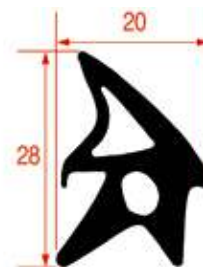

LF Code	Dimensions	Suitable INOXTREND	Suitable LOTUS	Suitable MODULAR
3186397	2200 mm	C5220-00	RRC5220-00	RRC5220-00
3186414	2600 mm	C5737-00		
3186398	2820 mm	C5221-00		RRC5221-00
3186413	3200 mm	C5738-00		

Profilo . Profile . Profil . Perfil

5022

In elastomero siliconico . Silicone elastomer
Silikonelastomer . Elastomero de silicona

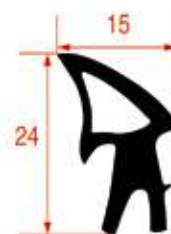

LF Code	Dimensions	Suitable INOXTREND	Suitable LOTUS
3186412	1420 mm	C6090-00	_C6090-00

Profilo . Profile . Profil . Perfil

5023

In elastomero siliconico . Silicone elastomer
Silikonelastomer . Elastomero de silicona

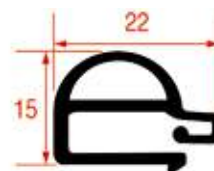

LF Code	Dimensions	Suitable ALPENINOX	Suitable ZANUSSI
3186040	715x645 mm	053751	053751
3286087	3 m	053751-3m	053751-3m
3286039	6 m	053751-6m	053751-6m
3286040	25 m	053751-25m	053751-25m

Profilo . Profile . Profil . Perfil

5024

In elastomero siliconico . Silicone elastomer
Silikonelastomer . Elastomero de silicona

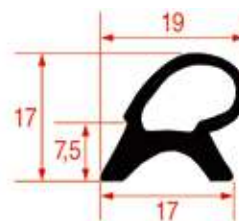

LF Code	Dimensions	Suitable ALPENINOX	Suitable WHIRLPOOL	Suitable ZANUSSI
3186041	585x395 mm	055414	771985003151	055414
3186043	720x640 mm	055315	771985003102	055315
3186354	1400x640 mm	054986	771985003063	054986

Profilo . Profile . Profil . Perfil

5025

In elastomero siliconico . Silicone elastomer
Silikonelastomer . Elastomero de silicona



LF Code	Dimensions	Suitable ALPENINOX	Suitable WHIRLPOOL	Suitable ZANUSSI
3186351	1140 mm	054850	771985003032	054850

Profilo . Profile . Profil . Perfil

5026

In elastomero siliconico . Silicone elastomer
Silikonelastomer . Elastomero de silicona



LF Code	Dimensions	Suitable INOXTREND	Suitable WHIRLPOOL
3186415	4500 mm	C7115-00	771985010296

Profilo . Profile . Profil . Perfil

5027

In elastomero siliconico . Silicone elastomer
Silikonelastomer . Elastomero de silicona



LF Code	Dimensions	Suitable UNOX
3786642	2500 mm	KGNO010A

Guarnizioni per porta forno
Oven door gaskets
Dichtungen für Ofentür
Burletes puerta horno

Profilo . Profile . Profil . Perfil

5028

In elastomero siliconico . Silicone elastomer
Silikonelastomer . Elastomero de silicona

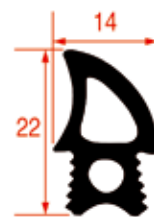

LF Code	Dimensions	Suitable UNOX
3186517	VENDITA AL METRO LINEARE SOLD PER METER	GN1000B0

Profilo . Profile . Profil . Perfil

5029

In elastomero siliconico . Silicone elastomer
Silikonelastomer . Elastomero de silicona

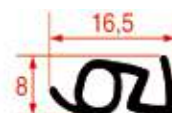

LF Code	Dimensions	Suitable GIERRE
3186154	1500 mm	GUA320

Profilo . Profile . Profil . Perfil

5030

In elastomero siliconico . Silicone elastomer
Silikonelastomer . Elastomero de silicona



LF Code	Dimensions	Suitable EMMEPI	Suitable SOGECO
3786116	VENDITA AL METRO LINEARE SOLD PER METER	8C0917	04-GRN-003

Profilo . Profile . Profil . Perfil

5031

In elastomero siliconico . Silicone elastomer
Silikonelastomer . Elastomero de silicona

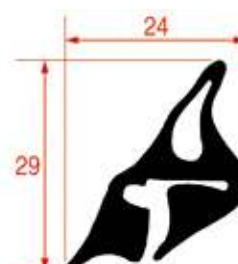

LF Code	Dimensions	Suitable ELOMA
3186523	1640 mm	693219

Profilo . Profile . Profil . Perfil

5032

In elastomero siliconico . Silicone elastomer
Silikonelastomer . Elastomero de silicona

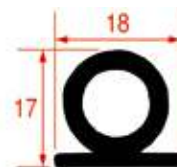

LF Code	Dimensions	Suitable CAPIC
3786303	VENDITA AL METRO LINEARE SOLD PER METER	I304006

Profilo . Profile . Profil . Perfil

5033

In elastomero siliconico . Silicone elastomer
Silikonelastomer . Elastomero de silicona

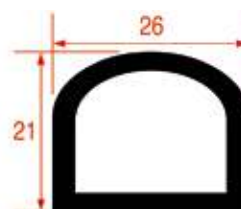

LF Code	Dimensions	Suitable CAPIC
3786306	VENDITA AL METRO LINEARE SOLD PER METER	I304018

Profilo . Profile . Profil . Perfil

5034

In elastomero siliconico . Silicone elastomer
Silikonelastomer . Elastomero de silicona

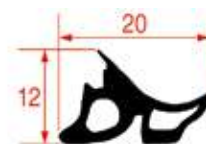

LF Code	Dimensions	Suitable CONVOTHERM
3786617	1500 mm	7011051
5053270	1900 mm	7011055

Profilo . Profile . Profil . Perfil

5035

In elastomero siliconico . Silicone elastomer
Silikonelastomer . Elastomero de silicona



LF Code	Dimensions	Suitable CONVOTHERM
3186399	2000 mm	7001039K

Guarnizioni per porta forno
Oven door gaskets
Dichtungen für Ofentür
Burletes puerta horno

Profilo . Profile . Profil . Perfil

5036

In elastomero siliconico . Silicone elastomer
Silikonelastomer . Elastomero de silicona

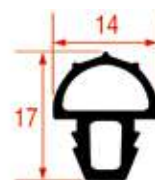

LF Code	Dimensions	Suitable COVEN
3786513	VENDITA AL METRO LINEARE SOLD PER METER	MCGP3/4P

Profilo . Profile . Profil . Perfil

5037

In elastomero siliconico . Silicone elastomer
Silikonelastomer . Elastomero de silicona



LF Code	Dimensions	Suitable BOURGEOIS	Suitable SOLYMAC
3786355	780x640 mm	JOIN031	FS12

Profilo . Profile . Profil . Perfil

5038

In elastomero siliconico . Silicone elastomer
Silikonelastomer . Elastomero de silicona

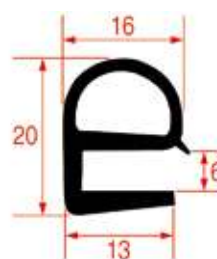

LF Code	Dimensions	Suitable BOURGEOIS
3786612	2660 mm	JOIN1015

Profilo . Profile . Profil . Perfil

5039

In elastomero siliconico . Silicone elastomer
Silikonelastomer . Elastomero de silicona

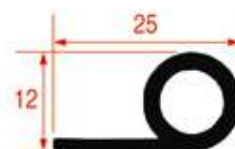

LF Code	Dimensions	Suitable CAPIC
3786304	VENDITA AL METRO LINEARE SOLD PER METER	I304008

Profilo . Profile . Profil . Perfil

5040

In elastomero siliconico . Silicone elastomer
Silikonelastomer . Elastomero de silicona

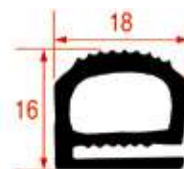

LF Code	Description	Suitable CAPIC
3786312	VENDITA AL METRO LINEARE SOLD PER METER	

Profilo . Profile . Profil . Perfil

5041

In elastomero siliconico . Silicone elastomer
Silikonelastomer . Elastomero de silicona

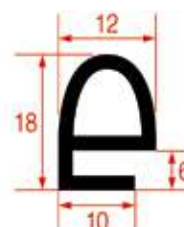

LF Code	Dimensions	Suitable BOURGEOIS	Suitable HOBART
5014799	2000 mm		845052
3786699	2030 mm	KITJOIN082	
5027581	2500 mm		492466
3786700	2550 mm	KITJOIN018	
3786359	3900 mm	JOIN019	

Profilo . Profile . Profil . Perfil

5042

In elastomero siliconico . Silicone elastomer
Silikonelastomer . Elastomero de silicona

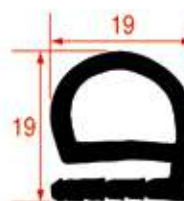

LF Code	Dimensions	Suitable KÜPPERSBUSCH
3786735	VENDITA AL METRO LINEARE SOLD PER METER	062329

Profilo . Profile . Profil . Perfil

5043

In elastomero siliconico . Silicone elastomer
Silikonelastomer . Elastomero de silicona



LF Code	Dimensions	Suitable ROSINOX
3786340	VENDITA AL METRO LINEARE SOLD PER METER	RX94050309

Guarnizioni per porta forno
Oven door gaskets
Dichtungen für Ofentür
Burletes puerta horno

Profilo . Profile . Profil . Perfil

5044

In elastomero siliconico . Silicone elastomer
Silikonelastomer . Elastomero de silicona

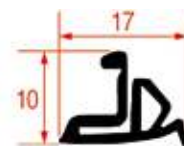

LF Code	Dimensions	Suitable ALPENINOX	Suitable ZANUSSI
4005885	1600 mm	005885	005885

Profilo . Profile . Profil . Perfil

5045

In elastomero siliconico . Silicone elastomer
Silikonelastomer . Elastomero de silicona

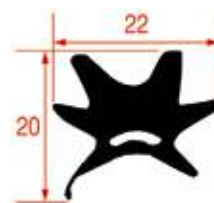

LF Code	Dimensions	Suitable MBM
3186157	680x460 mm	PAFOC00574
3186158	720x680 mm	PAFOC00575

Profilo . Profile . Profil . Perfil

5046

In elastomero siliconico . Silicone elastomer
Silikonelastomer . Elastomero de silicona

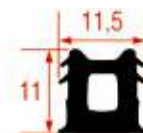

LF Code	Dimensions	Suitable LAINOX
5022831	2500 mm	R70042870
5011388	3000 mm	R70043270
5021244	4000 mm	R70043280
3286045	6 m	R70042870-6m
3286046	25 m	R70042870-25m

Profilo . Profile . Profil . Perfil

5047

In elastomero siliconico . Silicone elastomer
Silikonelastomer . Elastomero de silicona



LF Code	Dimensions	Suitable ALPENINOX	Suitable ZANUSSI
3786544	1300 mm	078168	078168

Profilo . Profile . Profil . Perfil

5048

In elastomero siliconico . Silicone elastomer
Silikonelastomer . Elastomero de silicona



LF Code	Dimensions	Suitable EBERHARDT	Suitable ROSINOX	Suitable SILKO
5004998	1650 mm	214526	RX94806445	LB848-00

Profilo . Profile . Profil . Perfil

5049

In elastomero siliconico . Silicone elastomer
Silikonelastomer . Elastomero de silicona



LF Code	Dimensions	Suitable BONNET	Suitable HOBART	Suitable THIRODE
3786602	1000 mm	366350	366350	366350

Profilo . Profile . Profil . Perfil

5050

In elastomero siliconico . Silicone elastomer
Silikonelastomer . Elastomero de silicona



LF Code	Dimensions	Suitable BONNET	Suitable BOURGEOIS
3786316	VENDITA AL METRO LINEARE SOLD PER METER	71206E	PROF777

Profilo . Profile . Profil . Perfil

5051

In elastomero siliconico . Silicone elastomer
Silikonelastomer . Elastomero de silicona



LF Code	Dimensions	Suitable BAKE OFF
5053760	4000 mm	331800011

Profilo . Profile . Profil . Perfil

5052

In elastomero siliconico . Silicone elastomer
Silikonelastomer . Elastomero de silicona

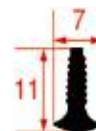

LF Code	Dimensions	Suitable BONNET	Suitable BOURGEOIS	Suitable HOBART
3786318	VENDITA AL METRO LINEARE SOLD PER METER	71876E	PROF1612	492455

Guarnizioni per porta forno
Oven door gaskets
Dichtungen für Ofentür
Burletes puerta horno

Profilo . Profile . Profil . Perfil

5053

In elastomero siliconico . Silicone elastomer
Silikonelastomer . Elastomero de silicona

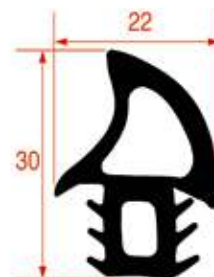

LF Code	Dimensions	Suitable GIORIK
3186506	VENDITA AL METRO LINEARE SOLD PER METER	7070166

Profilo . Profile . Profil . Perfil

5054

In elastomero siliconico . Silicone elastomer
Silikonelastomer . Elastomero de silicona



LF Code	Dimensions	Suitable CAPIC
3786307	VENDITA AL METRO LINEARE SOLD PER METER	I304024

Profilo . Profile . Profil . Perfil

5055

In elastomero siliconico . Silicone elastomer
Silikonelastomer . Elastomero de silicona

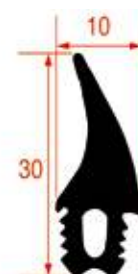

LF Code	Dimensions	Suitable COVEN
3786618	3000 mm	MCGFC06N

Profilo . Profile . Profil . Perfil

5056

In elastomero siliconico . Silicone elastomer
Silikonelastomer . Elastomero de silicona

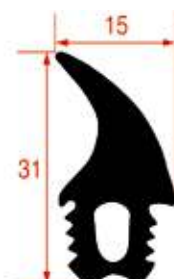

LF Code	Dimensions	Suitable KELVIN
3786088	2200 mm	0201504

Profilo . Profile . Profil . Perfil

5058

In elastomero siliconico . Silicone elastomer
Silikonelastomer . Elastomero de silicona

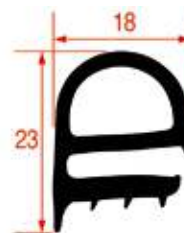

LF Code	Dimensions	Suitable RATIONAL	Suitable ROSINOX
3186156	485x470 mm	50120703	RX24390379
3186155	720x485 mm	50120704	RX24390338

Profilo . Profile . Profil . Perfil

5059

In elastomero siliconico . Silicone elastomer
Silikonelastomer . Elastomero de silicona

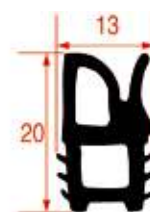

LF Code	Dimensions	Suitable LAINOX
3186471	1000 mm	R70041150

Profilo . Profile . Profil . Perfil

5201

In elastomero siliconico . Silicone elastomer
Silikonelastomer . Elastomero de silicona

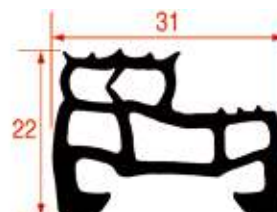

LF Code	Dimensions	Suitable ANGELO PO
5051485	510 mm	3091160

Profilo . Profile . Profil . Perfil

5202

In elastomero siliconico . Silicone elastomer
Silikonelastomer . Elastomero de silicona

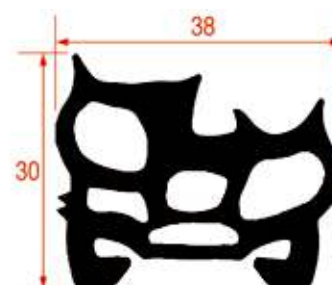

LF Code	Dimensions	Suitable ANGELO PO
3786598	505 mm	3040480
3786596	700 mm	3039710

Guarnizioni per porta forno
Oven door gaskets
Dichtungen für Ofentür
Burletes puerta horno

Profilo . Profile . Profil . Perfil

5203

In elastomero siliconico . Silicone elastomer
Silikonelastomer . Elastomero de silicona



LF Code	Dimensions	Suitable CONVOTHERM
5030831	without guide - 540 mm	7011009
7104024	with guide - 540 mm	2525227
3786616	with guide - 740 mm	2525226

Profilo . Profile . Profil . Perfil

5204

In elastomero siliconico . Silicone elastomer
Silikonelastomer . Elastomero de silicona

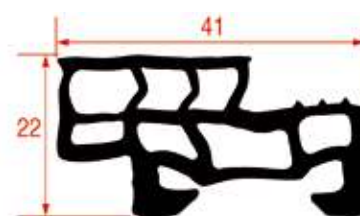

LF Code	Dimensions	Suitable ANGELO PO
5050046	515 mm	3199570
5050047	720 mm	3199580

Profilo . Profile . Profil . Perfil

5205

In elastomero siliconico . Silicone elastomer
Silikonelastomer . Elastomero de silicona

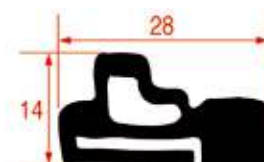

LF Code	Dimensions	Suitable LAINOX
3786062	700 mm	R70044300
7103904	1 pz lenght 500 mm 2 pz lenght 150 mm	R70044370
5039777	1 pz lenght 735 mm 2 pz lenght 150 mm	R70044360

Profilo . Profile . Profil . Perfil

5206

In elastomero siliconico . Silicone elastomer
Silikonelastomer . Elastomero de silicona



LF Code	Dimensions	Suitable BOURGEOIS
3786356	3500 mm	JOIN088

Profilo . Profile . Profil . Perfil

5207

In elastomero siliconico . Silicone elastomer
Silikonelastomer . Elastomero de silicona

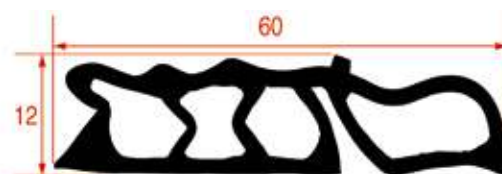

LF Code	Dimensions	Suitable FAGOR	Suitable RATIONAL
3186482	610 mm	RT51051025	51051025
3786495	825 mm	RT51051026	51051026

Profilo . Profile . Profil . Perfil

5208

In elastomero siliconico . Silicone elastomer
Silikonelastomer . Elastomero de silicona



LF Code	Dimensions	Suitable ALPENINOX	Suitable ZANUSSI
3786124	650 mm	0H6662	0H6662

Profilo . Profile . Profil . Perfil

5209

In elastomero siliconico . Silicone elastomer
Silikonelastomer . Elastomero de silicona

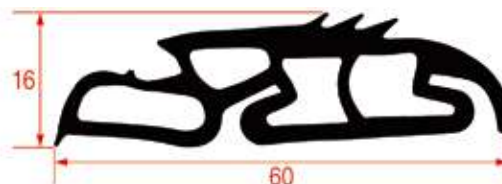

LF Code	Dimensions	Suitable ALPENINOX	Suitable ZANUSSI
3786123	745 mm	0C1196	0C1196

Profilo . Profile . Profil . Perfil

5210

In elastomero siliconico . Silicone elastomer
Silikonelastomer . Elastomero de silicona

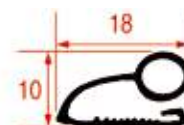

LF Code	Dimensions	Suitable SMEG
3186495	510 mm	754130321

Guarnizioni per porta forno
Oven door gaskets
Dichtungen für Ofentür
Burletes puerta horno

Profilo . Profile . Profil . Perfil

5301

In elastomero siliconico . Silicone elastomer
Silikonelastomer . Elastomero de silicona

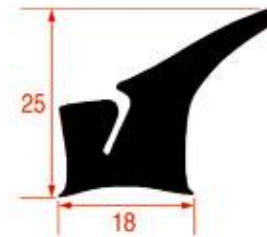

LF Code	Dimensions	Suitable SOGECO
3286049	3 m	GUARNIZIONE001-3M
3286050	15 m	GUARNIZIONE00115M

Profilo . Profile . Profil . Perfil

5302

In elastomero siliconico . Silicone elastomer
Silikonelastomer . Elastomero de silicona

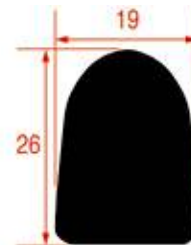

LF Code	Dimensions	Suitable KÜPPERSBUSCH	Suitable RATIONAL	Suitable ROSINOX
3286025	7 m	062392	20120200-7M	RX24390510
3286026	21 m	062392	20120200-21M	RX24390510

Profilo . Profile . Profil . Perfil

5303

In elastomero siliconico . Silicone elastomer
Silikonelastomer . Elastomero de silicona



LF Code	Dimensions	Suitable ELOMA	Suitable RATIONAL
5042060	SOLD PER METER	131385	
3286083	3 m	131385-3M	3286083-3M
3286023	6 m	131385-6M	3286023-6M
3286024	25 m	131385-25M	3286024-25M

Profilo . Profile . Profil . Perfil

5304

In elastomero siliconico . Silicone elastomer
Silikonelastomer . Elastomero de silicona

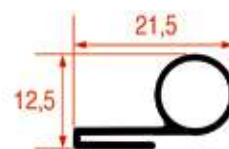

LF Code	Dimensions	Suitable COVEN
3286086	3 m	MCGP0002-3M
3286033	6 m	MCGP0002-6M
3286034	25 m	MCGP0002-25M

Profilo . Profile . Profil . Perfil

5305

In elastomero siliconico . Silicone elastomer
Silikonelastomer . Elastomero de silicona

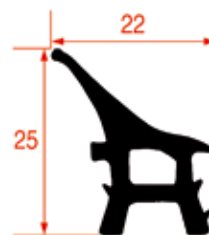

LF Code	Dimensions	Suitable COVEN	Suitable EMMEPI
3286051	3 m	MCGPN004-3M	9629918-3M
3286052	15 m	MCGPN004-15M	9629918-15M

Profilo . Profile . Profil . Perfil

5306

In elastomero siliconico . Silicone elastomer
Silikonelastomer . Elastomero de silicona



LF Code	Dimensions	Suitable FOEMM
3286081	3 m	305150024240-3M
3286017	6 m	305150024240-6M
3286018	25 m	305150024240-25M

Profilo . Profile . Profil . Perfil

5307

In elastomero siliconico . Silicone elastomer
Silikonelastomer . Elastomero de silicona

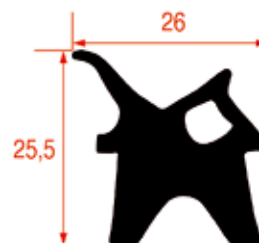

LF Code	Dimensions	Suitable EBERHARDT	Suitable FOINOX	Suitable LAINOX
3286085	3 m	216239-3M	14021-3M	R70042030-3M
3286031	6 m	216239-6M	14021-6M	R70042030-6M
3286032	25 m	216239-25M	14021-25M	R70042030-25M

Profilo . Profile . Profil . Perfil

5308

In elastomero siliconico . Silicone elastomer
Silikonelastomer . Elastomero de silicona

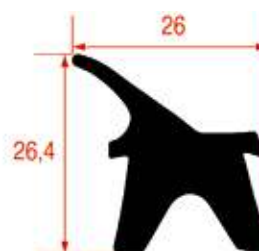

LF Code	Dim.	Suitable ANGELO PO	Suitable BERTO'S	Suitable EMMEPI	Suitable FOINOX	Suitable GIGA	Suitable GIORIK	Suitable INOXTREND	Suitable LAINOX	Suitable MODULAR	Suitable REPAGAS
5013418	635x480mm			809796			7070173				
3186311	740x630mm			8C0029			7070174				
3286084	3 m	37Q2480	25596700	8C1193	3351	R37700	7070190	C2215	R70041540	RRC2215-03	140012
3286029	6 m	37Q2480	25596700	8C1193	3351	R37700	7070190	C2215	R70041540	RRC2215-03	140012
3286030	15 m	37Q2480	25596700	8C1193	3351	R37700	7070190	C2215	R70041540	RRC2215-03	140012

Guarnizioni per porta forno
Oven door gaskets
Dichtungen für Ofentür
Burletes puerta horno

Profilo . Profile . Profil . Perfil

5309

In elastomero siliconico . Silicone elastomer
Silikonelastomer . Elastomero de silicona



LF Code	Dimensions	Suitable BAKE OFF	Suitable ERRE 2	Suitable GICO
3286076	3 m	331800008	284201490	293201400
3286003	6 m	331800008-6M	284201490-6M	293201400-6M
3286004	24 m	331800008-24M	284201490-24M	293201400-24M

Profilo . Profile . Profil . Perfil

5310

In elastomero siliconico . Silicone elastomer
Silikonelastomer . Elastomero de silicona



LF Code	Dimensions	Suitable ALPENINOX	Suitable JUNO	Suitable ZANUSSI
3286079	3 m	0H6760	253241	0H6760
3286013	6 m	0H6760	253241	0H6760
3286014	25 m	0H6760	253241	0H6760

Profilo . Profile . Profil . Perfil

5311

In elastomero siliconico . Silicone elastomer
Silikonelastomer . Elastomero de silicona

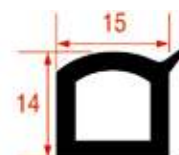

LF Code	Dimensions	Suitable ALPENINOX	Suitable JUNO	Suitable ZANUSSI
3286078	3 m	0H6767	253382	0H6767
3286011	6 m	0H6767	253382	0H6767
3286012	25 m	0H6767	253382	0H6767

Profilo . Profile . Profil . Perfil

5312

In elastomero siliconico . Silicone elastomer
Silikonelastomer . Elastomero de silicona

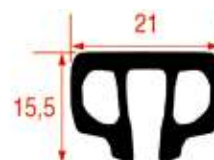

LF Code	Dimensions	Suitable ALPENINOX	Suitable JUNO	Suitable ZANUSSI
3286082	3 m	0H6663	246283	0H6663
3286021	6 m	0H6663	246283	0H6663
3286022	24 m	0H6663	246283	0H6663

Profilo . Profile . Profil . Perfil

5313

In elastomero siliconico . Silicone elastomer
Silikonelastomer . Elastomero de silicona

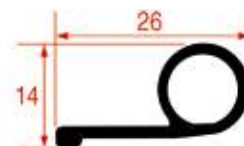

LF Code	Dimensions	Suitable ALPENINOX	Suitable WHIRLPOOL	Suitable ZANUSSI
3286075	3 m	057656	771985003465	057656
3286001	6 m	057656	771985003465	057656
3286002	20 m	057656	771985003465	057656

Profilo . Profile . Profil . Perfil

5314

In elastomero siliconico . Silicone elastomer
Silikonelastomer . Elastomero de silicona

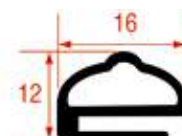

LF Code	Dimensions	Suitable ALPENINOX	Suitable ZANUSSI
3286088	3 m	OLD MODELS	OLD MODELS
3286041	6 m	OLD MODELS	OLD MODELS
3286042	25 m	OLD MODELS	OLD MODELS

Profilo . Profile . Profil . Perfil

5315

In elastomero siliconico . Silicone elastomer
Silikonelastomer . Elastomero de silicona

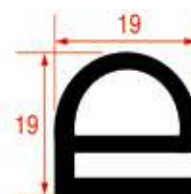

LF Code	Dimensions	Suitable RATIONAL	Suitable ROSINOX
3286077	3 m	50120700	RX24390288
3286005	6 m	50120700	RX24390288
3286006	25 m	50120700	RX24390288

Profilo . Profile . Profil . Perfil

5401

In elastomero siliconico . Silicone elastomer
Silikonelastomer . Elastomero de silicona



LF Code	Dimensions	Suitable ANGELO PO
3786092	1400 mm	36E2830
3786093	1850 mm	36E2840
3786094	2000 mm	36E3930
3786095	2400 mm	36E3480

Guarnizioni per porta forno
Oven door gaskets
Dichtungen für Ofentür
Burletes puerta horno

Profilo . Profile . Profil . Perfil

5402

In elastomero siliconico . Silicone elastomer
Silikonelastomer . Elastomero de silicona

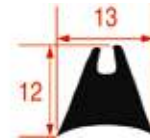

LF Code	Dimensions	Suitable ANGELO PO
3186362	1400 mm	37Q2982
3186364	1800 mm	37Q2992
3186366	2100 mm	37Q7531
3186368	2600 mm	37Q3001
5013397	3100 mm	37Q7621

Profilo . Profile . Profil . Perfil

5403

In elastomero siliconico . Silicone elastomer
Silikonelastomer . Elastomero de silicona

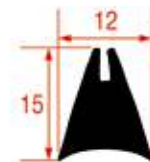

LF Code	Dimensions	Suitable BERTO'S	Suitable EMMEPI	Suitable FOINOX	Suitable REPAGAS
3186344	1100 mm	25594000	809024	30093	
3186345	1700 mm		808666	1441+1441	1250054
3186346	4400 mm		808665	1444	1240011

Profilo . Profile . Profil . Perfil

5404

In elastomero siliconico . Silicone elastomer
Silikonelastomer . Elastomero de silicona

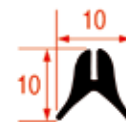

LF Code	Dimensions	Suitable BONNET	Suitable BOURGEOIS	Suitable HOBART
3786317	VENDITA AL METRO LINEARE SOLD PER METER	71209E	JOIN063	845320-1

Profilo . Profile . Profil . Perfil

5405

In elastomero siliconico . Silicone elastomer
Silikonelastomer . Elastomero de silicona



LF Code	Dimensions	Suitable CAPIC
3786302	VENDITA AL METRO LINEARE SOLD PER METER	I304004

Profilo . Profile . Profil . Perfil

5406

In elastomero siliconico . Silicone elastomer
Silikonelastomer . Elastomero de silicona



LF Code	Dimensions	Suitable RATIONAL	Suitable ROSINOX
3786623	VENDITA AL METRO LINEARE SOLD PER METER	50120200	RX24390502

Profilo . Profile . Profil . Perfil

5407

In elastomero siliconico . Silicone elastomer
Silikonelastomer . Elastomero de silicona



LF Code	Dimensions	Suitable SMEG
3186504	1650 mm	754130476

Profilo . Profile . Profil . Perfil

5408

In elastomero siliconico . Silicone elastomer
Silikonelastomer . Elastomero de silicona

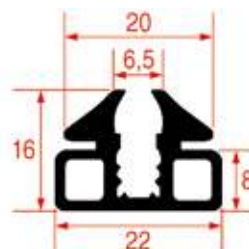

LF Code	Dimensions	Suitable ALPENINOX	Suitable ZANUSSI
3186352	1400 mm	055412	055412
3186355	2200 mm	055314	055314

Profilo . Profile . Profil . Perfil

5409

In elastomero siliconico . Silicone elastomer
Silikonelastomer . Elastomero de silicona

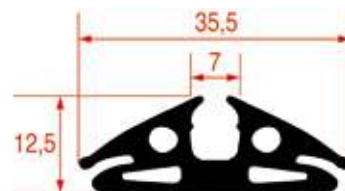

LF Code	Dimensions	Suitable ALPENINOX	Suitable ZANUSSI
3186423	1500 mm	003680	003680

Profilo . Profile . Profil . Perfil

5410

In elastomero siliconico . Silicone elastomer
Silikonelastomer . Elastomero de silicona

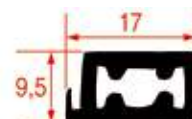

LF Code	Dimensions	Suitable GIORIK
3786073	VENDITA AL METRO LINEARE SOLD PER METER	7070179

Guarnizioni per porta forno
Oven door gaskets
Dichtungen für Ofentür
Burletes puerta horno

Profilo . Profile . Profil . Perfil

5411

In elastomero siliconico . Silicone elastomer
Silikonelastomer . Elastomero de silicona



LF Code	Dimensions	Suitable GIORIK
3786072	VENDITA AL METRO LINEARE SOLD PER METER	7070167

Profilo . Profile . Profil . Perfil

5412

In elastomero siliconico . Silicone elastomer
Silikonelastomer . Elastomero de silicona



LF Code	Dimensions	Suitable INOXTREND
3786107	3500 mm	C7116-00

Profilo . Profile . Profil . Perfil

5413

In elastomero siliconico . Silicone elastomer
Silikonelastomer . Elastomero de silicona

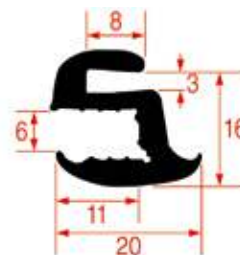

LF Code	Dimensions	Suitable ALPENINOX	Suitable JUNO	Suitable ZANUSSI
3186407	2000 mm	002878	002878	002878
3186409	2010 mm	003739		003739

Profilo . Profile . Profil . Perfil

5414

In elastomero siliconico . Silicone elastomer
Silikonelastomer . Elastomero de silicona



LF Code	Dimensions	Suitable FAGOR
5029467	VENDITA AL METRO LINEARE SOLD PER METER	3715200000

Profilo . Profile . Profil . Perfil

5415

In elastomero siliconico . Silicone elastomer
Silikonelastomer . Elastomero de silicona

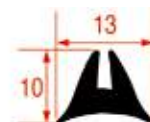

LF Code	Dimensions	Suitable KELVIN
3786087	1200 mm	0201502

Profilo . Profile . Profil . Perfil

5416

In elastomero siliconico . Silicone elastomer
Silikonelastomer . Elastomero de silicona



LF Code	Dimensions	Suitable LAINOX
3186464	1700 mm	R70040730
3186465	2100 mm	R70040640
3786065	2700 mm	R70044150

Profilo . Profile . Profil . Perfil

5417

In elastomero siliconico . Silicone elastomer
Silikonelastomer . Elastomero de silicona



LF Code	Dimensions	Suitable MARENO
3186372	1670 mm	MA2842200R

Profilo . Profile . Profil . Perfil

5418

In elastomero siliconico . Silicone elastomer
Silikonelastomer . Elastomero de silicona



LF Code	Dimensions	Suitable MBM
3186316	VENDITA AL METRO LINEARE SOLD PER METER	MPGOM03P00

Profilo . Profile . Profil . Perfil

5419

In elastomero siliconico . Silicone elastomer
Silikonelastomer . Elastomero de silicona



LF Code	Dimensions	Suitable MORICE
3786300	1400 mm	DM0549-1

Guarnizioni per porta forno
Oven door gaskets
Dichtungen für Ofentür
Burletes puerta horno

Profilo . Profile . Profil . Perfil

5420

In elastomero siliconico . Silicone elastomer
Silikonelastomer . Elastomero de silicona

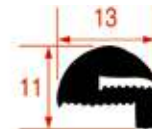

LF Code	Dimensions	Suitable COVEN
3786179	3500 mm	MCGV0002_3,5
3786171	7000 mm	MCGV0002_7

Profilo . Profile . Profil . Perfil

5421

In elastomero siliconico . Silicone elastomer
Silikonelastomer . Elastomero de silicona



LF Code	Dimensions	Suitable COVEN
3786324	1300 mm	MCGV0003

Profilo . Profile . Profil . Perfil

5422

In elastomero siliconico . Silicone elastomer
Silikonelastomer . Elastomero de silicona



LF Code	Dimensions	Suitable FAGOR
3186325	5000 mm	3713800000

Profilo . Profile . Profil . Perfil

5423

In elastomero siliconico . Silicone elastomer
Silikonelastomer . Elastomero de silicona

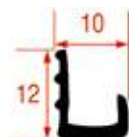

LF Code	Dimensions	Suitable FAGOR
3186153	VENDITA AL METRO LINEARE SOLD PER METER	3713700000

Profilo . Profile . Profil . Perfil

5601



In elastomero siliconico . Silicone elastomer
Silikonelastomer . Elastomero de silicona

LF Code	Dimensions	Suitable FOINOX
3786111	443 mm	14026
3786108	490 mm	14018
3786110	492 mm	14027
3786114	655 mm	14019
3786109	1210 mm	14017

Profilo . Profile . Profil . Perfil

5701

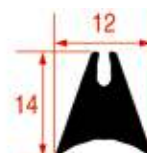

In elastomero siliconico . Silicone elastomer
Silikonelastomer . Elastomero de silicona

LF Code	Dimensions	Suitable ANGELO PO	Suitable BERTO'S	Suitable EMMEPI	Suitable GIGA	Suitable LAINOX
3286027	6 m	37Q2470-6M	23601400-6M	R70040120-6M	7070161-6M	50505821
3286028	25 m	37Q2470-25M	23601400-25M	R70040120-25M	7070161-25M	50505821

Profilo . Profile . Profil . Perfil

5702

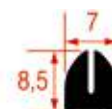

In elastomero siliconico . Silicone elastomer
Silikonelastomer . Elastomero de silicona

LF Code	Dimensions	Suitable CONVOTHERM
3286009	5 m	7001041-5M
3286010	25 m	7001041-25M

Profilo . Profile . Profil . Perfil

5703



In elastomero siliconico . Silicone elastomer
Silikonelastomer . Elastomero de silicona

LF Code	Dimensions	Suitable RATIONAL	Suitable ROSINOX
3286047	6 m	50120200-6M	RX24390502
3286048	25 m	50120200-25M	RX24390502

Guarnizioni per porta forno
Oven door gaskets
Dichtungen für Ofentür
Burletes puerta horno

Profilo . Profile . Profil . Perfil

5704

In elastomero siliconico . Silicone elastomer
Silikonelastomer . Elastomero de silicona



LF Code	Dimensions	Suitable ALPENINOX	Suitable ZANUSSI
3286035	9 m	057866-9M	057866-9M
3286036	20 m	057866-20M	057866-20M

Profilo . Profile . Profil . Perfil

5705

In elastomero siliconico . Silicone elastomer
Silikonelastomer . Elastomero de silicona



LF Code	Dimensions	Suitable ALPENINOX	Suitable ZANUSSI
3286037	9 m	OLD MODELS	OLD MODELS
3286038	20 m	OLD MODELS	OLD MODELS

Profilo . Profile . Profil . Perfil

5706

In elastomero siliconico . Silicone elastomer
Silikonelastomer . Elastomero de silicona

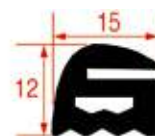

LF Code	Dimensions	Suitable CONVOTHERM
3286007	5 m	7001042-5M
3286008	25 m	7001042-25M

Profilo . Profile . Profil . Perfil

5707

In elastomero siliconico . Silicone elastomer
Silikonelastomer . Elastomero de silicona

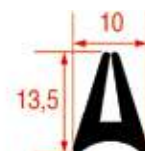

LF Code	Dimensions	Suitable ELOMA
3286019	6 m	425041-7M
3286020	25 m	425041-25M

Guarnizioni porta lavastoviglie

Door gaskets for dishwashers

Türdichtungen für Spülmaschine

Burletes puerta lavavajilla



Ricambi in qualità originale

Spare parts of original quality

Ersatzteile in Originalqualität

Repuestos en calidad original



Adattabili per tutti i migliori marchi

Suitable for all the major brands

Passend für die bekanntesten Hersteller

Adaptables para las mejores marcas

Alba
Alpeninox
Angelo Po
Bonnet
Comenda
Dexion

Electrolux
Hobart
Hoonved
Marels
Metos
Rhima

Thirode
Winterhalter
Zanussi

Guarnizioni porta lavastoviglie
Door gaskets for dishwashers
Türdichtungen für Spülmaschine
Burletes puerta lavavajilla

Alpeninox

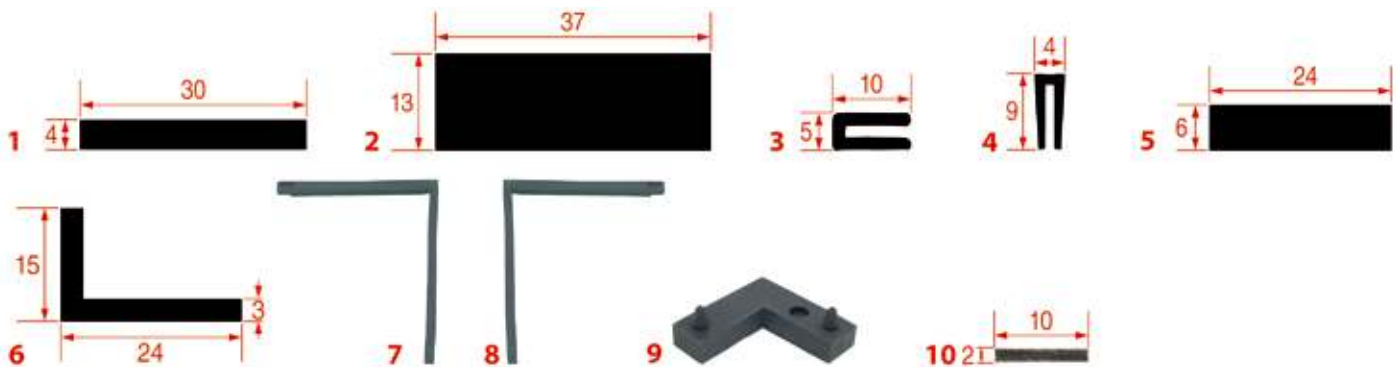

Photo	LF Code	Dimensions	Profile	Suitable for
1	3186108	435 mm	30x4 mm	049017
2	3186300	600 mm	37x13 mm	046394
3	3786550	700 mm	10x5 mm	0E5559
4	4049016	1000 mm	9x4 mm	049016
5	40L0021	590 mm	23x5 mm	0L0021
6	3186301	565	24x15 mm	0L2561
7	3186302	310x260 mm		047454
8	3186303	310x260 mm		047455
9	3222001	69x69 mm		045836
10	3186470	4750 mm	10x2 mm	046583
11	3189015	**	25x4 mm	0K9154

Angelo Po



Photo	LF Code	Dimensions	Profile	Suitable for
1	3186176	445 mm	28x6 mm	37Q3910

Aristarco

** Vendita al metro . Sold per meter . Meterware . Venta por metro

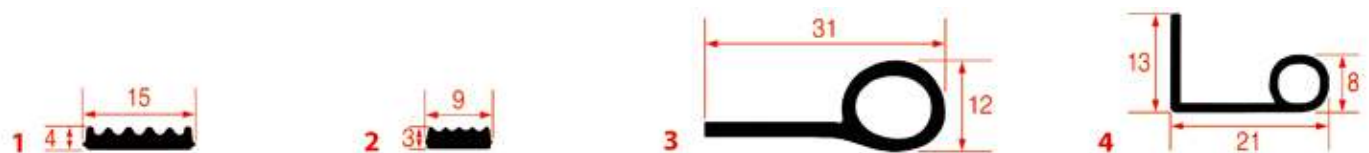

Photo	LF Code	Dimensions	Profile	Suitable for
1	3786647	1000 mm	15x4 mm	6143
2	5051453	**	9x3 mm	6233
3	5024708	**	31X12 mm	4623
4	5020820	1000 mm	13x21x8 mm	4897

Ata

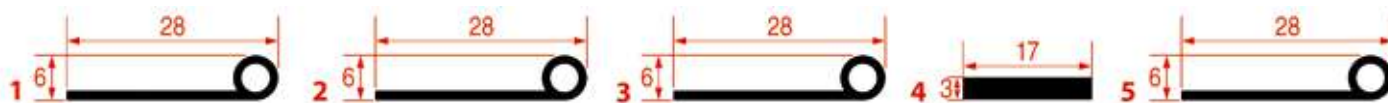

Photo	LF Code	Dimensions	Profile	Suitable for
1	3186176	445 mm	28x6 mm	7629
2	3186177	470 mm	28x6 mm	7148
3	3186178	590 mm	28x6 mm	4669
4	3186927	595 mm	17x3 mm	4678
5	5014112	478 mm	28x6 mm	6814

Bartscher

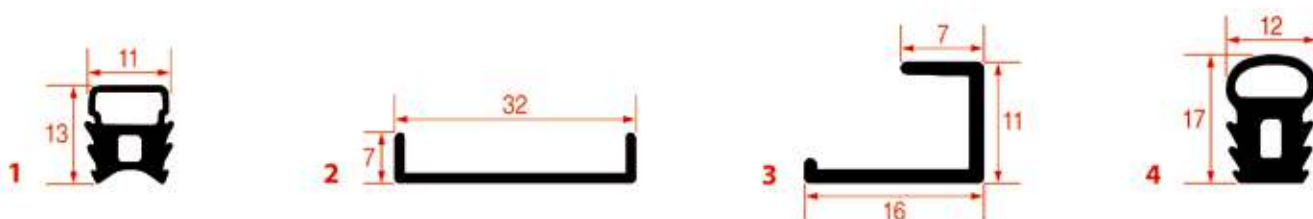

Photo	LF Code	Dimensions	Profile	Suitable for
1	3786035	1370 mm	13x11 mm	0437088
2	3786037	567 mm	32x7 mm	0437081
3	6437058	430 mm	16x11x7 mm	0437058
4	6437071	1160 mm	17x12 mm	0437071

Bonnet



Photo	LF Code	Dimensions	Profile	Suitable for
1	3786035	1370 mm	13x11 mm	2001365H
2	3786037	567 mm	32x2 mm	2001364H

Guarnizioni porta lavastoviglie
Door gaskets for dishwashers
Türdichtungen für Spülmaschine
Burletes puerta lavavajilla

Colged

** Vendita al metro . Sold per meter . Meterware . Venta por metro

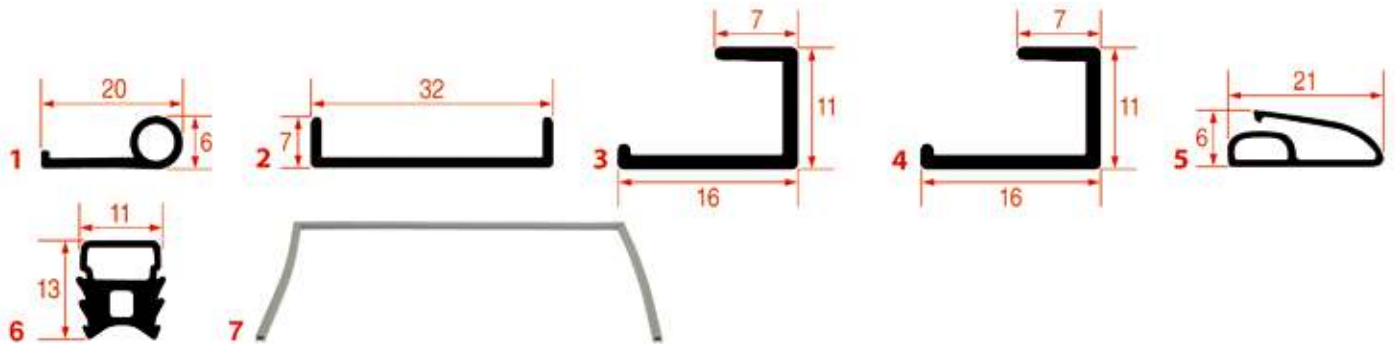

Photo	LF Code	Dimensions	Profile	Suitable for
1	3786034	**	20x6 mm	41247
2	3786037	567 mm	32x7 mm	REB437081
3	6437057	395 mm	16x11x7 mm	REB437057
4	6437058	430 mm	16x11x7 mm	REB437058
5	6437075	590 mm	21x6 mm	REB437075
6	3786035	1370 mm	13x11 mm	437088
2	6437052	585 mm	32x7 mm	437052
7	6437103	555x400 mm	-	437103

Comenda

** Vendita al metro . Sold per meter . Meterware . Venta por metro

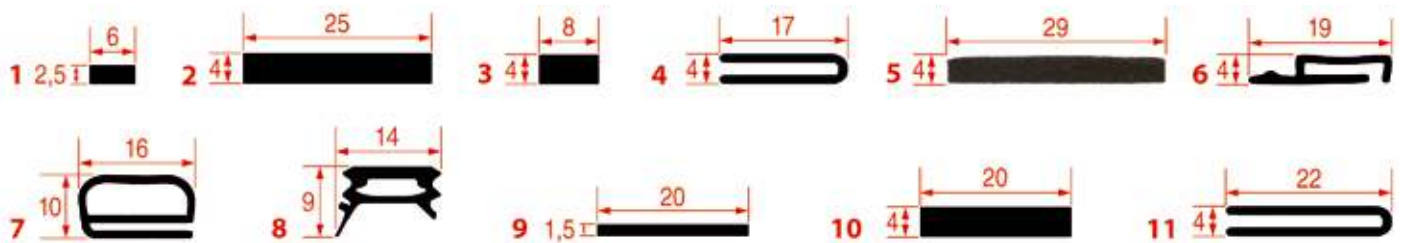

Photo	LF Code	Dimensions	Profile	Suitable for
1	3189012	**	6x2,5 mm	200433
2	3189015	**	25x4 mm	200402
3	3189014	**	8x4 mm	200432
4	3186444	1000 mm	17x4 mm	200215
5	3186445	600 mm	29x4 mm	200497
6	3186252	**	19x4 mm	200923
7	5028249	**	16x10 mm	H36883
8	5054472	560x445 mm	14x9 mm	200974
9	5024484	1000 mm	20x1,5 mm	200925
10	5008523	600 mm	20x4 mm	200924
11	5009327	1000 mm	22x4 mm	200945

Dihr



Photo	LF Code	Dimensions	Profile	Suitable for
1	3187013	1500 mm	24x10 mm	560021
2	7100611	1000 mm	17x10 mm	135205

Electrolux

** Vendita al metro . Sold per meter . Meterware . Venta por metro

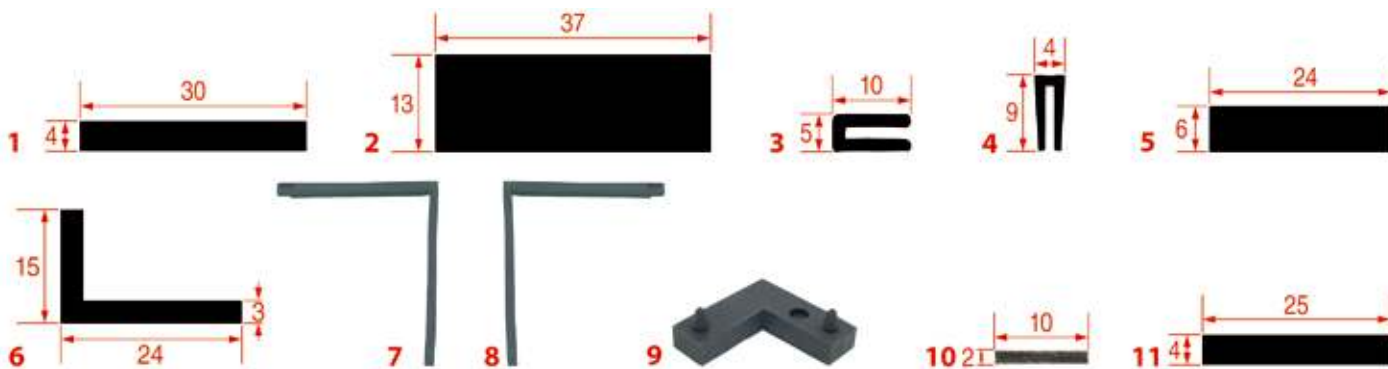

Photo	LF Code	Dimensions	Profile	Suitable for
1	3186108	435 mm	30x4 mm	049017
2	3186300	600 mm	37x13 mm	046394
3	3786550	700 mm	10x5 mm	0E5559
4	4049016	1000 mm	9x4 mm	049016
5	40L0021	590 mm	23x5 mm	0L0021
6	3186301	565	24x15 mm	0L2561
7	3186302	310x260 mm		047454
8	3186303	310x260 mm		047455
9	3222001	69x69 mm		045836
10	3186470	4750 mm	10x2 mm	046583
11	3189015	**	25x4 mm	0K9154

Guarnizioni porta lavastoviglie
Door gaskets for dishwashers
Türdichtungen für Spülmaschine
Burletes puerta lavavajilla

Elettrobar

** Vendita al metro . Sold per meter . Meterware . Venta por metro

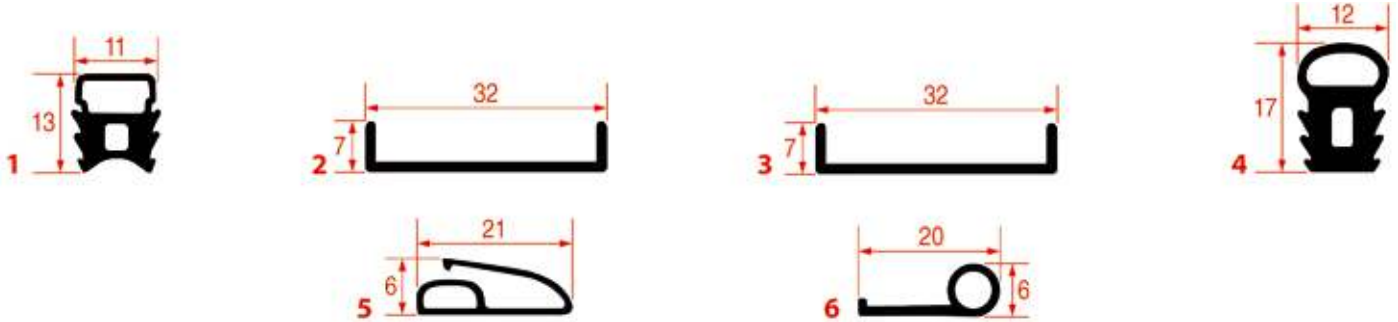

Photo	LF Code	Dimensions	Profile	Suitable for
1	3786035	1370 mm	13x11 mm	437097
2	3786037	567 mm	32x7 mm	437081
3	6437052	585	32x7 mm	437052
4	6437071	1160 mm	17x12 mm	437071
5	6437075	590 mm	21x6 mm	437075
6	3786034	**	20x6 mm	41247MT

Elframo



Photo	LF Code	Dimensions	Suitable for
1	3186092	340x222 mm	00001440

Fagor

** Vendita al metro . Sold per meter . Meterware . Venta por metro

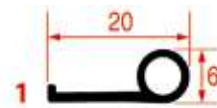

Photo	LF Code	Dimensions	Suitable for
1	3786034	**	EU41247

Hobart



Photo	LF Code	Dimensions	Suitable for
1	5030387	560 mm	886253-1

Hoonved

** Vendita al metro . Sold per meter . Meterware . Venta por metro

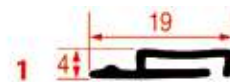

Photo	LF Code	Dimensions	Profile	Suitable for
1	3186252	**	19x4 mm	H200923

Komel



Photo	LF Code	Dimensions	Suitable for
1	3186092	340x222 mm	00001440

Kromo



Photo	LF Code	Dimensions	Profile	Suitable for
1	3187013	1500 mm	24x10 mm	560021
2	7100611	1000 mm	17x10 mm	135205

Marels



Photo	LF Code	Dimensions	Profile	Suitable for
1	3186072	600 mm	23x5 mm	453.030.00

Mbm

** Vendita al metro . Sold per meter . Meterware . Venta por metro



Photo	LF Code	Dimensions	Profile	Suitable for
1	3786035	1370 mm	13x11 mm	437088
2	3786037	567 mm	32x7 mm	437081
3	6437052	585 mm	32x7 mm	437052
4	3786034	**	20x6 mm	41247M

Modular



Photo	LF Code	Dimensions	Profile	Suitable for
1	3186072	600 mm	23x5 mm	453.030.00

Guarnizioni porta lavastoviglie
Door gaskets for dishwashers
Türdichtungen für Spülmaschine
Burletes puerta lavavajilla

Rancilio

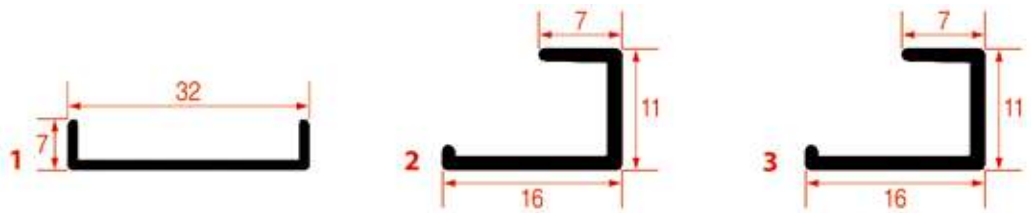

Photo	LF Code	Dimensions	Profile	Suitable for
1	3786037	567 mm	32x7 mm	65437081
2	6437058	430 mm	16x11x7 mm	65437058
3	6437057	395 mm	16x11x7 mm	65437057

Rhima

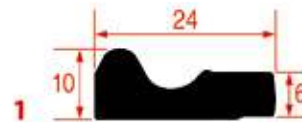

Photo	LF Code	Dimensions	Profile	Suitable for
1	3187013	1500 mm	24x10	50730010

Thirode



Photo	LF Code	Dimensions	Profile	Suitable for
1	3786035	1370 mm	13x11 mm	2001365H
2	3786037	567 mm	32x7 mm	2001364H

Whirlpool

** Vendita al metro . Sold per meter . Meterware . Venta por metro

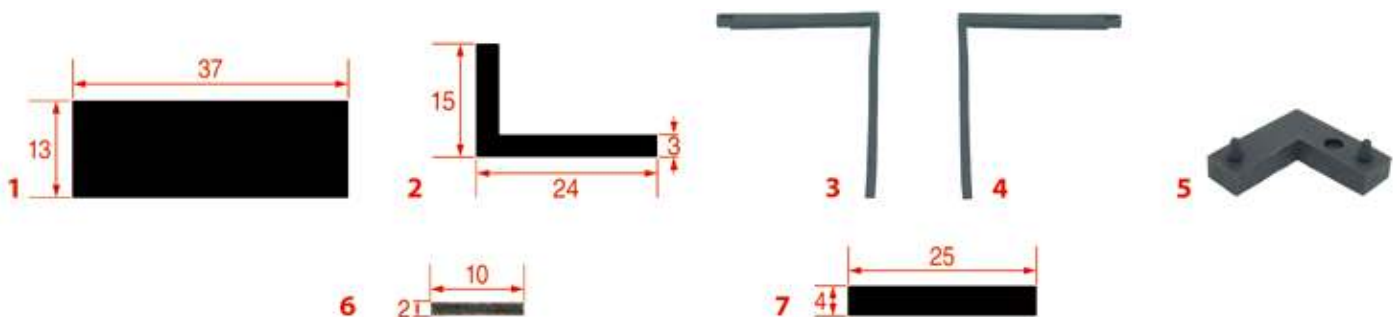

Photo	LF Code	Dimensions	Profile	Suitable for
1	3186300	600 mm	37x13 mm	771985001229
1	3186301	565X310 mm		771985002124
3	3186302	310x260 mm		771985001612
4	3186303	310x260 mm		771985001613
5	3222001	69x69 mm		771985001110
6	3186470	4750 mm	10x2 mm	771985001301
7	3189015	**	25x4 mm	249154

Guarnizioni porta lavastoviglie
 Door gaskets for dishwashers
 Türdichtungen für Spülmaschine
 Burletes puerta lavavajilla

Zanussi

** Vendita al metro . Sold per meter . Meterware . Venta por metro



Photo	LF Code	Dimensions	Profile	Suitable for
1	3186108	435 mm	30x4 mm	049017
2	3186300	600 mm	37x13 mm	046394
3	4049016	1000 mm	9x4 mm	049016
4	40L0021	590 mm	23x5 mm	0L0021
5	3186301	565x310 mm	24x15 mm	0L2561
6	3186302	310x260 mm		047454
7	3186303	310x260 mm		047455
8	3222001	69x69 mm		045836
9	3786550	700 mm	10x5 mm	0E5559
10	3189015	**	25x4 mm	0K9154



The most extensive range of industrially manufactured **quality gaskets** for commercial refrigeration

DO IT YOURSELF

Guarnizioni in barre e angolari per il fai da te in situazioni di emergenza

2 soluzioni:

- barre da 2 m = 4 angoli da saldare
- barre a "L" = 2 angoli da saldare

2 modi di saldatura:

- con saldatura a caldo
- con angolare di supporto e colla

Gaskets in bars and L-shape for a do-it-yourself in emergencies

2 solutions:

- 2-metre bars = 4 edges to be welded
- "L" profile = 2 edges to be welded

2 welding solutions:

- heat-welding
- with angle support and glue

Dichtungen in Streifen oder in L-FormLösungen für Selbstbaudichtungen (wenn's schnell gehen muß..)

2 Lösungen:

- 2-Meter Streifen = 4 Ecken zu Schweißen
- "L" Profile = 2 Ecken zu Schweißen

2 Schweiß-Lösungen:

- mit hoher Temperatur
- mit Eckverbindern und Klebstoffen

Burletes en barras y angulares (en L) para soluciones hazlo tú mismo de emergencia

2 soluciones:

- barras de 2 metros = 4 ángulos a unir
- Forma en "L" = 2 ángulos a unir

2 soluciones para unir:

- con calor
- con soporte angular y adhesivo

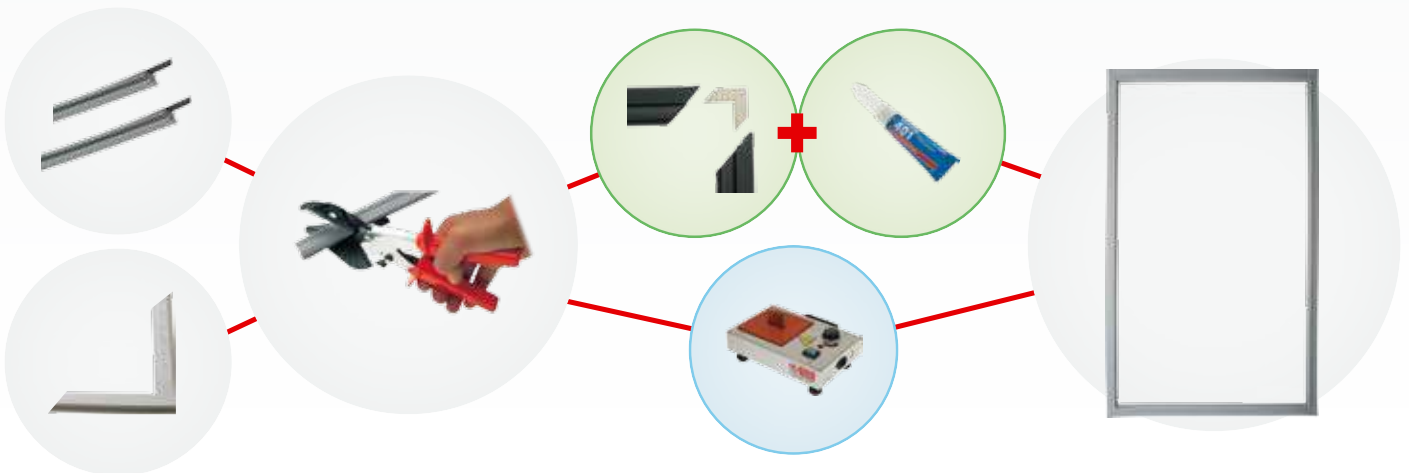

Guarnizioni per forni in matasse da 3, 6, 20 e 25 metri

Ovens gaskets in 3, 6, 20 and 25-metre bundles

Öfendichtungen in 3, 6, 20 und 25-Meter-Rollen

Burletes para hornos en rollos de 3, 6, 20 y 25 metros



www.lfspareparts724.com

Guarnizioni per lavabiancheria
Gaskets for laundry machines
Dichtungen für Waschmaschinen
Juntas para lavadoras



Ricambi in qualità originale
Spare parts of original quality
Ersatzteile in Originalqualität
Repuestos en calidad original

Adattabili per tutti i migliori marchi
Suitable for all the major brands
Passend für die bekanntesten Hersteller
Adaptables para las mejores marcas



Asko
Danube
Domus
Electrolux
Girbau
Ipsa

Miele
Polimatic
Wascator
Zanussi



Guarnizioni per lavabiancheria
Gaskets for laundry machines
Dichtungen für Waschmaschinen
Juntas para lavadoras

Aga



Photo	LF Code	Dimensions	Suitable for
1	3786205	∅ 265 mm	L8/D35
2	3786206	∅ 335 mm	L8/D203
3	3786207	∅ 365 mm	L14/D3
4	3786208	∅ 470 mm	L22/D3
5	3786209	∅ 510 mm	LC44/D3
6	3786210	∅ 405 mm	LC16/D3
7	3786211	∅ 400 mm	E50/D3

Alpeninox



Photo	LF Code	Dimensions	Suitable for
1	3186020	∅ 295 mm	060669
2	3186021	∅ 360 mm	047659
3	3186261	∅ 325 mm	072257
4	3186264	∅ 300 mm	072304
5	3186180	∅ 400 mm	0E1907
6	3186490	∅ 310 mm	0E1748
7	3786101	1550 mm	0W0963
8	3786102	∅ 385 mm	0W5614
9	3786103	∅ 410 mm	0W5615
10	3786104	∅ 278 mm	0E1677
10	3786105	∅ 238 mm	0W2041
11	4072333	∅ 310 mm	072333
13	40W2418	2800 mm	0W2418
14	3686001	∅ 450 mm	0W1Y0T

Asko



Photo	LF Code	Dimensions	Suitable for
1	3786419	ø 340 mm	8064025
2	3786572	425x30 mm	8061980
3	3786573	490x30 mm	8061616

Danube



Photo	LF Code	Dimensions	Suitable for
1	3186110	ø 335 mm	422170001500
2	3186113	ø 400 mm	422230012200
3	3786152	ø 395 mm	P620528000
4	3786153	ø 310 mm	SAVW080019
5	3786141	ø 440 mm	SAVZOD0048
6	3786145	ø 405 mm	SAVW250009

Domus



Photo	LF Code	Dimensions	Suitable for
1	3786145	ø 405 mm	4XFP530502000
2	3786152	ø 395 mm	4XFP620528000
3	3786153	ø 310 mm	4XFP440502000

Guarnizioni per lavabiancheria
Gaskets for laundry machines
Dichtungen für Waschmaschinen
Juntas para lavadoras

Electrolux



Photo	LF Code	Dimensions	Suitable for
1	3186020	ø 295 mm	060669
2	3186021	ø 360 mm	047659
3	3186261	ø 325 mm	072257
4	3186264	ø 300 mm	072304
5	3186180	ø 400 mm	0E1907
6	3186490	ø 310 mm	0E1748
7	3786101	1550 mm	0W0963
8	3786102	ø 385 mm	0W5614
9	3786103	ø 410 mm	0W5615
10	3786104	ø 278 mm	0E1677
11	3786105	ø 328 mm	0W2041
12	4072333	ø 310 mm	072333
14	40W2418	2800 mm	0W2418
15	3686001	ø 450 mm	0W1Y0T

Fagor



Photo	LF Code	Dimensions	Suitable for
1	3786145	ø 405 mm	P530502000
2	3786152	ø 395 mm	P620528000
3	3786153	ø 310 mm	P610508000

Girbau



Photo	LF Code	Dimensions	Suitable for
1	3786160	ø 345 mm	187146
2	3786161	ø 390 mm	352161
3	3786162	ø 460 mm	342899
4	7101816	ø 360 mm	563353
5	3786164	1900 mm	AS102354

Grandimpianti



Photo	LF Code	Dimensions	Suitable for
1	3186024	ø 325 mm	50GI503004
2	3186110	ø 335 mm	422170001500
3	3186111	ø 420 mm	50505000041
4	3186112	ø 350 mm	400002401901
5	3186113	ø 400 mm	422230012200
6	3186128	ø 630 mm	50GI505001
7	3187019	3000 mm	422230024200
8	3786137	1000 mm	50GI505058
9	3786140	ø 430 mm	440000529575
10	3786141	ø 440 mm	422230006800
11	3786143	ø 435 mm	443115021905
12	3786154	ø 530 mm	445108001814
13	3786419	ø 340 mm	36ASK8064025
14	5048612	ø 565 mm	442107003214

Guarnizioni per lavabiancheria
Gaskets for laundry machines
Dichtungen für Waschmaschinen
Juntas para lavadoras

Imesa



Photo	LF Code	Dimensions	Suitable for
1	3186121	ø 330 mm	4010902A
2	3186124	ø 400 mm	930908
3	3186128	ø 630 mm	7998GUVASL81
4	3186129	ø 650 mm	4000106X
5	3186130	ø 300 mm	3941GUA28ESS
6	3186133	1500 mm	1960TUBSI152
7	3786127	ø 420 mm	4010416X
8	3786128	2000 mm	950612
9	3786419	ø 340 mm	ASK8064025
10	3786572	425x30 mm	ASK8061980
11	3786573	490x30 mm	ASK8061616

Ipsos



Photo	LF Code	Dimensions	Suitable for
1	3186110	ø 335 mm	217/00015/00
2	3186113	ø 400 mm	223/00122/00
3	3187019	3000 mm	B12351601
4	3786141	ø 440 mm	223/00068/00
5	7103485	ø 390 mm	255/00123/00

Miele



Photo	LF Code	Dimensions	Suitable for
1	2101202	ø 338 mm	0070210
2	3786148	ø 370 mm	2492302
3	3786149	ø 330 mm	6816000
4	3786413	ø 330 mm	4119291
5	5038603	ø 335 mm	0067559

Polimatic



Photo	LF Code	Dimensions	Suitable for
1	3186024	ø 325 mm	PRI503000004
2	3186113	ø 400 mm	PRI505000045
3	3786142	ø 560 mm	273115021915
4	3786143	ø 435 mm	273115021905
5	3786154	ø 530 mm	273112001766

Primus



Photo	LF Code	Dimensions	Suitable for
1	3186024	ø 325 mm	PRI503000004
2	3186111	ø 420 mm	PRI505000041
3	3186113	ø 400 mm	PRI505000045
4	3786142	ø 560 mm	F02107003214
5	3786143	ø 435 mm	273115021905
6	3786154	ø 530 mm	273112001766
7	3786415	ø 330 mm	BL00002401903
8	3786419	ø 340 mm	8064025
9	3786434	ø 640 mm	PRI505000001
10	3786570	ø 430 mm	529575
11	3786571	ø 580 mm	RSPM406129
12	3786572	425x30 mm	8061980
13	3786573	490x30 mm	8061616

Socolmatic



Photo	LF Code	Dimensions	Suitable for
1	3186116	ø 440 mm	A29
2	5014253	2250 mm	A38

Guarnizioni per lavabiancheria
Gaskets for laundry machines
Dichtungen für Waschmaschinen
Juntas para lavadoras

Wascator



Photo	LF Code	Dimensions	Suitable for
1	3186180	ø 400 mm	438046201
2	3186264	ø 300 mm	472871701
3	3786102	ø 385 mm	432184101
4	3786104	ø 278 mm	438505201
5	3786105	ø 328 mm	432184001
6	4072333	ø 310 mm	472873101
7	40W2418	2800 mm	438815505
9	3686001	ø 450 mm	432184303

Zanussi



Photo	LF Code	Dimensions	Suitable for
1	3186020	ø 295 mm	060669
2	3186021	ø 360 mm	047659
3	3186180	ø 400 mm	0E1907
4	3186261	ø 325 mm	072257
5	3186264	ø 300 mm	072304
6	3186490	ø 310 mm	0E1748
7	3786102	ø 385 mm	0W5614
8	3786103	ø 410 mm	0W5615
9	3786104	ø 278 mm	0E1677
10	3786105	ø 328 mm	0W2041
11	4072333	ø 310 mm	072333
12	40W2418	2800 mm	0W2418
13	40W5858	ø 450 mm	0W5858

Whirlpool



Photo	LF Code	Dimensions	Suitable for
1	3186020	ø 295 mm	771985003880
2	3186024	ø 325 mm	771985008727
3	3186111	ø 420 mm	PRI505000041
4	3186113	ø 400 mm	771985008741
5	3186121	ø 330 mm	483286002979
6	3186124	ø 400 mm	483286008592
7	3186133	1500 mm	483286001275
8	3786127	ø 420 mm	483286008357
9	3786128	2000 mm	483286001274
10	3786148	ø 370 mm	771985007987
11	3786413	ø 330 mm	771985008417
12	3786414	ø 620 mm	771985011734
13	3786415	ø 330 mm	771985009000
14	3786419	ø 340 mm	771985010618
15	3786420	ø 385 mm	481246068617
16	3786421	530 mm	771985011732
17	3786422	510 mm	481246668784
18	3786424	ø 555 mm	481246668785
19	3786434	ø 640 mm	771985008796
20	3786501	2400 mm	483286008444
21	3786570	ø 430 mm	771985011488
22	3786571	ø 580 mm	771985008894
23	3786572	425x30 mm	483286009877
24	3786573	490x30 mm	483286009878



- 🇮🇹 **Magazzino per guarnizioni = 700 m²**
- 🇬🇧 **Warehouse for gaskets = 700 sqm**
- 🇩🇪 **Lager für Dichtungen = 700 m²**
- 🇪🇸 **Almacén para burletes = 700 m²**



Magazzino operativo 700 m²
Delivery warehouse 700 sqm
Verwaltetes Lager 700 m²
Almacén operativo 700 m²



7 corsie
7 aisles
7 Gänge
7 pasillos



Magazzino riserve/scorte 250 m²
Stock warehouse 250 sqm
Lager für Vorräte 250 m²
Almacén reservas/existencias 250 m²



Questo è l'impegno e l'investimento che abbiamo sostenuto per assicurare guarnizioni di produzione industriale invece di guarnizioni artigianali.



This is the effort and the investment we have undertaken to ensure gaskets of industrial production quality instead of hand-made ones.



Es ist diese Investition, die LF dazu verpflichtet, Ihnen keine Hand-gefertigten Dichtungen sondern Dichtungen industrieller Produktion und Qualität anzubieten.



Este es el compromiso y la inversión que nos hemos elegido para garantizarles los burletes de producción industrial; **ninguna producción propia artesana!**

Le ragioni della qualità

Where quality lies

Woran man Qualität erkennt

Las razones de la calidad



1

Qualità della mescola e uniformità dello spessore del profilo (estrusione)

- Quality of the compound and uniformity in the profile thickness (extrusion)
- Qualität der Granulatmischung und Gleichmässigkeit in der Profildicke (Extrusion)
- Calidad de la mezcla y uniformidad del espesor del perfil (extrusión)



2

Qualità/forza del magnete permanente

- Quality/strength of the permanent magnet
- Qualität und Stärke des Permanentmagneten
- Calidad/fuerza del imán permanente



3

Perfetta saldatura degli angoli e senza sbavature

- Clean and perfect welding of corners
- Perfekt sauber verschweißte Ecken
- Perfecta soldadura de los ángulos y sin rebabas

4



Lo stoccaggio/imballaggio delle guarnizioni non deve sottoporre gli angoli a tensioni

- The storage/packing of gaskets must not put corners under stress
- Die Lagerung und der Versand von Dichtungen darf die Ecken nicht belasten
- El almacenaje/embalaje de los burletes no debe someter los ángulos a tensión

5

Un notevole investimento nella gestione delle guarnizioni e l'allocazione di ampi spazi del magazzino per il loro stoccaggio fanno sì che LF sia l'unico distributore ad offrire il più vasto programma di guarnizioni di produzione industriale!

- Erhebliche Investitionen in Dichtung-Handhabung und die Zuweisung von breiten Bereichen des Lagers für Dichtungslagerung ermöglichen es LF, der einzige Vertrieb zu sein, der die breiteste Auswahl an Dichtungen von industrieller Produktion bietet!

A significant investment in gasket management and the allocation of large warehouse spaces for the storage of gaskets make LF the only distributor able to offer the widest range of industrial production gaskets!

Una inversión considerable en la gestión de los burletes y la asignación de grandes áreas del almacén para su almacenamiento es lo que hace que ¡LF sea el único distribuidor que ofrecer la gama más completa de burletes de la producción industrial!





Corda . Thickness . Dicke . Grosor

1,78mm

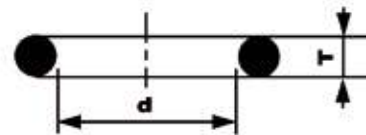

Dimensions (mm) T x d	Model new cross references	Model old cross references	LF Code (EPDM)	LF Code (VITON)	LF Code (SILICONE)
1.78 x 1.78	OR 02007		2111723		
1.78 x 2.57	OR 02010		1186163	1186746	
1.78 x 2.90	OR 02012	OR 0101	1186365	1186842	1186846
1.78 x 3.69	OR 02015	OR 0102	1186014	1186900 - 1786095	1186514 - 1786278
1.78 x 4.48	OR 02018	OR 0103	1186421	1186755	1186861 - 1786127
1.78 x 5.28	OR 02021	OR 0104	1186362	1786112 - 1786088 - 1786144	1186903 - 5056235
1.78 x 6.07	OR 02025	OR 0105	3243139	1186612 - 1786143	1786079 - 1186611 - 1486013
1.78 x 6.75	OR 0106	OR 0106	3243009	1186435	1186864
1.78 x 7.66	OR 02031	OR 0107	1186411	1786085 - 1186717 - 1786107	1186901
1.78 x 8.73	OR 0108	OR 0108	1186422	1186707	1186902
1.78 x 9.25	OR 02037	OR 0110	1186803	1186088 - 1786274 - 1786267	1786087
1.78 x 10.82	OR 02043		1186346	1186950	5008673
1.78 x 11.11	OR 0114	OR 0114	1186626	1186730	1786075 - 1186877
1.78 x 12.42	OR 02050		1186352		1186366
1.78 x 14.00	OR 02056		1186223	1786154 - 5037375	1786061
1.78 x 15.60	OR 02062		1186424	1786232 - 1786208	1786159
1.78 x 17.17	OR 02068		3243069	1786271 - 1786165	
1.78 x 18.77	OR 02075		3186440	1186933	5008687
1.78 x 20.35	OR 02081		3243266		1186373
1.78 x 21.95	OR 02087		3243382	1786277	
1.78 x 23.52	OR 02093		1186401		
1.78 x 25.12	OR 02100		3186169		
1.78 x 26.70	OR 02106		3186343		1186863
1.78 x 28.30	OR 02112		3186754	1186631	
1.78 x 29.87	OR 02118		5010533		4005527

Corda . Thickness . Dicke . Grosor

1,78mm

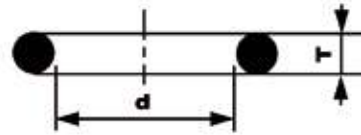

Dimensions (mm) T x d	Model new cross references	Model old cross references	LF Code (EPDM)	LF Code (VITON)	LF Code (SILICONE)
1.78 x 31.47	OR 02125		3243191	1186919	1786139
1.78 x 33.05	OR 02131		1186003		3186317
1.78 x 34.65	OR 02137		3243189	1186929	5060454
1.78 x 36.27	OR 02142				1786122
1.78 x 37.82	OR 02150				1786102
1.78 x 39.45	OR 02155				
1.78 x 41.00	OR 02162			1186960	
1.78 x 44.17	OR 02175				
1.78 x 47.35	OR 02187		7102065		3186657
1.78 x 50.52	OR 02200		1186956		
1.78 x 53.70	OR 02212				
1.78 x 56.87	OR 02225				
1.78 x 60.05	OR 02237		6456037		
1.78 x 63.22	OR 02250				
1.78 x 66.40	OR 02262				
1.78 x 69.57	OR 02275				
1.78 x 72.75	OR 02287		5059891		
1.78 x 75.92	OR 02300		1186397		
1.78 x 82.27	OR 02325		6456074		
1.78 x 88.62	OR 02350		3186232		
1.78 x 94.97	OR 02375		3122121		
1.78 x 101.32	OR 02400				
1.78 x 107.67	OR 02425				
1.78 x 114.02	OR 02450				
1.78 x 120.37	OR 02475		3122365		
1.78 x 126.72	OR 02500				
1.78 x 133.07	OR 02525		3186239		

Corda . Thickness . Dicke . Grosor

1,90mm

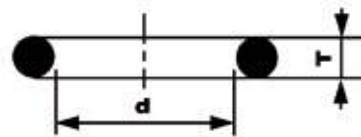

Dimensions (mm) T x d	Model new cross references	Model old cross references	LF Code (EPDM)	LF Code (VITON)	LF Code (SILICONE)
1.90 x 2.40	OR R0		1786108		
1.90 x 2.60	OR R1				
1.90 x 3.40	OR R2		2104557		
1.90 x 4.20	OR R3		1186996		
1.90 x 4.90	OR R4		1786286		
1.90 x 5.70	OR R5		1186854		1186610
1.90 x 7.20	OR R6		1186556	1186791	
1.90 x 8.90	OR R7				
2.20 x 9.00	OR R7bis				

Guarnizioni O-Ring
O-Ring Gaskets
O-Ring Dichtungen
Juntas O-Ring

Corda . Thickness . Dicke . Grosor

2,62mm

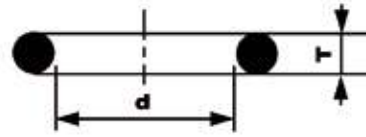

Dimensions (mm) T x d	Model new cross references	Model old cross references	LF Code (EPDM)	LF Code (VITON)	LF Code (SILICONE)
2.62 x 3.63	OR 03014		1186407	1186967	
2.62 x 4.42	OR 03017				
2.62 x 5.23	OR 03021				
2.62 x 6.02	OR 03024		3786668		1786137
2.62 x 7.59	OR 03030		1186358	1786155 - 1786197	1786280
2.62 x 9.13	OR 0109	OR 0109	1186255	5029740	1186910 - 3186608
2.62 x 9.19	OR 03037	OR 0111	3186340	1786202	
2.62 x 9.92	OR 0112	OR 0112	1186304	1186879	1186914 - 1786049 - 1786281
2.62 x 10.78	OR 03043	OR 0113	1186318	1186236	3786719
2.62 x 11.91	OR 0115	OR 0115	1186805	1186709	1186745
2.62 x 12.37	OR 03050	OR 0116	3060608	3090132	1186458
2.62 x 13.10	OR 0117	OR 0117	3243086		1186085 - 1786234
2.62 x 13.95	OR 03056	OR 0118	3186860		1186762
2.62 x 15.08	OR 0119	OR 0119	1186414	1186714	3523062
2.62 x 15.54	OR 03062	OR 0120	5033919		1186073 - 5039862
2.62 x 15.88	OR 0121	OR 0121	3186434	1186246	
2.62 x 17.13	OR 03068	OR 0122	3186181	1786276	1186850
2.62 x 17.86	OR 0123	OR 0123	3186287		1186000 - 1199001
2.62 x 18.72	OR 03075	OR 0124	1186356		5059295
2.62 x 20.24	OR 03081	OR 0127	1186327	5039864	1186026 - 1186053
2.62 x 20.63	OR 0128	OR 0128	3186183	1186591 - 1786300	
2.62 x 21.89	OR 03087		1786233		1186796
2.62 x 22.22	OR 0130	OR 0130	3186253		1186292
2.62 x 23.47	OR 03093		1186922		
2.62 x 23.81	OR 0132	OR 0132	1186438		
2.62 x 25.07	OR 03100		1186833		
2.62 x 26.65	OR 03106		1186759	5045475	1786243
2.62 x 28.25	OR 03112		3186247	5037072	7104228
2.62 x 29.82	OR 03118		3186458		
2.62 x 31.42	OR 03125		3186244	1186930	
2.62 x 32.99	OR 03131		3186847	5029479	1186920
2.62 x 34.60	OR 03137		3243250	1186767	
2.62 x 36.14	OR 03143		5027619		
2.62 x 37.77	OR 03150			1786145	3186775
2.62 x 39.34	OR 03156		3786183	1186184	
2.62 x 40.95	OR 03162		3243389		
2.62 x 42.52	OR 03168		3160040	1186705	
2.62 x 44.12	OR 03175		5008865		
2.62 x 45.69	OR 03181		1186466		
2.62 x 47.30	OR 03187		3160044		
2.62 x 48.89	OR 03193		1186672	5055114	
2.62 x 50.47	OR 03200		3186245	5034849 - 1186948	
2.62 x 52.07	OR 03206		4052206		
2.62 x 53.65	OR 03212		3060038		1186847
2.62 x 55.25	OR 03218		3186284	1186961	
2.62 x 56.82	OR 03225				

Corda . Thickness . Dicke . Grosor

2,62mm

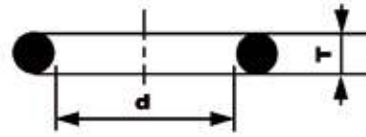

Dimensions (mm) T x d	Model new cross references	Model old cross references	LF Code (EPDM)	LF Code (VITON)	LF Code (SILICONE)
2.62 x 58.42	OR 03231		3186455		1199075
2.62 x 60.00	OR 03237		3243166		
2.62 x 61.60	OR 03243		3122252		
2.62 x 63.17	OR 03250		3186315		
2.62 x 64.77	OR 03256		1786203	1786153	
2.62 x 66.35	OR 03262			1786225	
2.62 x 67.95	OR 03268		3186248		
2.62 x 69.52	OR 03275				
2.62 x 71.12	OR 03281		1186625		1186405
2.62 x 72.69	OR 03287		1186152		
2.62 x 75.87	OR 03300		1186237	1186779	
2.62 x 78.94			3786579		
2.62 x 82.22	OR 03325		5006128		
2.62 x 88.57	OR 03350		5015751		1786124
2.62 x 94.92	OR 03375		1186605		
2.62 x 101.27	OR 03400				
2.62 x 107.62	OR 03425		5018599	1786224	
2.62 x 113.97	OR 03450				
2.62 x 120.32	OR 03475		6456067		
2.62 x 126.67	OR 03500				
2.62 x 133.02	OR 03525				
2.62 x 139.37	OR 03550				
2.62 x 145.72	OR 03575				
2.62 x 152.07	OR 03600				
2.62 x 158.42	OR 03625				
2.62 x 164.77	OR 03650				
2.62 x 171.12	OR 03675				
2.62 x 177.47	OR 03700				
2.62 x 183.82	OR 03725				
2.62 x 190.17	OR 03750				
2.62 x 196.52	OR 03775				
2.62 x 202.87	OR 03800				
2.62 x 209.22	OR 03825				
2.62 x 215.57	OR 03850		3786202		
2.62 x 221.92	OR 03875				
2.62 x 228.27	OR 03900				
2.62 x 234.62	OR 03925				
2.62 x 240.97	OR 03950				
2.62 x 247.32	OR 03975				

Guarnizioni O-Ring
O-Ring Gaskets
O-Ring Dichtungen
Juntas O-Ring

Corda . Thickness . Dicke . Grosor

3,53mm

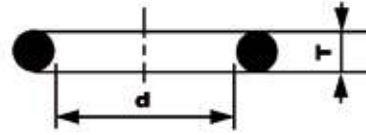

Dimensions (mm) T x d	Model new cross references	Model old cross references	LF Code (EPDM)	LF Code (VITON)	LF Code (SILICONE)
3.53 x 7.51	OR 04028				
3.53 x 9.12	OR 04036		6456047 - 5055347	2102713	
3.53 x 12.29	OR 04050				1186016
3.53 x 13.87	OR 04055		5056553		
3.53 x 15.47	OR 04061		1186019		3786053
3.53 x 17.04	OR 04067		3786519		
3.53 x 18.64	OR 04075	OR 0125	1186472	1186766	3186610
3.53 x 20.22	OR 04081	OR 0126	1186238	2111463	1186009
3.53 x 21.82	OR 04087	OR 0129	1186630	4059475	
3.53 x 23.40	OR 04093	OR 0131	3186143	5028161	1786050
3.53 x 24.99	OR 04100	OR 0133	5027608		
3.53 x 25.80	OR 00134	OR 0134			1186944
3.53 x 26.58	OR 04106	OR 0135	1186231		1786119
3.53 x 28.17	OR 04112	OR 0136	1186480	3786008 - 1786256	1186869 - 1786018
3.53 x 29.75	OR 04118	OR 0137	3243142	1186790 - 1786167	1186874 - 3186619 - 1786199
3.53 x 31.34	OR 04125	OR 0138	1186506		1186010
3.53 x 32.93	OR 04131	OR 0139	1186655	3186580 - 1786098	1786210
3.53 x 34.52	OR 04137	OR 0140	3061040	1186403	1186963 - 1186990
3.53 x 36.10	OR 04143	OR 0141	3186338	w	2101315 - 1786118
3.53 x 37.69	OR 04150	OR 0142	3186197	5034986	1186905 - 1786168
3.53 x 39.69	OR 0144	OR 0144	3186606		1786099 - 1186947
3.53 x 40.86	OR 04162		3067198 - 1786097	40C6450	5039021
3.53 x 41.28	OR 0146	OR 0146	3186238	1186798	
3.53 x 42.86	OR 0147	OR 0147	3186184	1786117	1786140
3.53 x 44.04	OR 04175		3186175	1786152	
3.53 x 44.45	OR 0149	OR 0149	5500239		
3.53 x 46.04	OR 0150	OR 0150	3786181		
3.53 x 47.22	OR 04187		3186290	1186190 - 5033985	
3.53 x 47.63	OR 0152	OR 0152	1186087	1186931	
3.53 x 49.21	OR 0153	OR 0153	3786454	5005318	1786116
3.53 x 50.39	OR 04200		3186601	3786459 - 1186928	4006406
3.53 x 50.80	OR 0155	OR 0155	3316031		1186503
3.53 x 52.39	OR 0156	OR 0156	5038549		
3.53 x 53.57	OR 04212		1186643	5501390	
3.53 x 53.98	OR 0158	OR 0158	5029231		1186461
3.53 x 55.56	OR 0159	OR 0159	3186697	1186715	
3.53 x 56.74	OR 04225		1186799		
3.53 x 57.15	OR 0161	OR 0161	1186198	1786292	
3.53 x 58.74	OR 0162	OR 0162	1186199	1786287	
3.53 x 59.92	OR 04237		3316110		
3.53 x 60.33	OR 0164	OR 0164	1186230	1786011	
3.53 x 61.91	OR 0165	OR 0165			
3.53 x 63.09	OR 04250		1186022		
3.53 x 63.50	OR 0167	OR 0167	3186454		1786298
3.53 x 65.09	OR 0168	OR 0168	1186645		
3.53 x 66.27	OR 04262			1186241	
3.53 x 66.68	OR 0170	OR 0170			1186367

Corda . Thickness . Dicke . Grosor

3,53mm

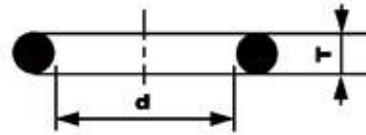

Dimensions (mm) T x d	Model new cross references	Model old cross references	LF Code (EPDM)	LF Code (VITON)	LF Code (SILICONE)
3.53 x 68.26	OR 0171	OR 0171	1186763		
3.53 x 69.44	OR 04275		5022973		1786209
3.53 x 69.85	OR 0173	OR 0173			
3.53 x 71.44	OR 0174	OR 0174	3243160		
3.53 x 72.62	OR 04287		2104550		1186880 - 1198009
3.53 x 73.03	OR 0176	OR 0176	1186641	1786254	1186858
3.53 x 74.61	OR 0177	OR 0177	3186289	5041924	1186457
3.53 x 75.80	OR 04300		1186748		1786110
3.53 x 78.97	OR 04312		3186271	1186698	1786268
3.53 x 82.14	OR 04325		1186693		
3.53 x 85.32	OR 04337		1186519		
3.53 x 88.50	OR 04350		1186873		1786261
3.53 x 91.67	OR 04362		3061007		
3.53 x 94.84	OR 04375		3061011		
3.53 x 98.02	OR 04387		3186137		
3.53 x 101.20	OR 04400		3160607	5501389	1786129
3.53 x 104.40	OR 04412				
3.53 x 107.50	OR 04425		3186235	1786214	
3.53 x 110.70	OR 04437		3061016		
3.53 x 113.90	OR 04450		3186456		
3.53 x 117.10	OR 04462		5038594		
3.53 x 120.20	OR 04475		3186466		1186806
3.53 x 123.40	OR 04487				
3.53 x 126.60	OR 04500				
3.53 x 129.80	OR 04512			5500526	
3.53 x 132.90	OR 04525		1186941		
3.53 x 136.10	OR 04537		1186708		
3.53 x 139.30	OR 04550				
3.53 x 142.50	OR 04562		2104552		
3.53 x 145.60	OR 04575				
3.53 x 148.80	OR 04587		3122552		
3.53 x 152.00	OR 04600				
3.53 x 158.30	OR 04625		3122255		
3.53 x 164.70	OR 04650		3122344		
3.53 x 171.00	OR 04675				
3.53 x 177.40	OR 04700				
3.53 x 183.70	OR 04725		3061037		
3.53 x 190.10	OR 04750				
3.53 x 196.40	OR 04775				
3.53 x 202.80	OR 04800				
3.53 x 209.10	OR 04825		5023163		
3.53 x 215.50	OR 04850				
3.53 x 221.80	OR 04875				
3.53 x 228.20	OR 04900				
3.53 x 234.50	OR 04925				
3.53 x 240.90	OR 04950				

Guarnizioni O-Ring
O-Ring Gaskets
O-Ring Dichtungen
Juntas O-Ring

Corda . Thickness . Dicke . Grosor

3,53mm

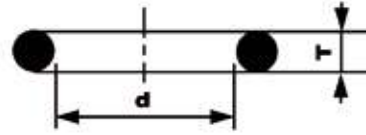

Dimensions (mm) T x d	Model new cross references	Model old cross references	LF Code (EPDM)	LF Code (VITON)	LF Code (SILICONE)
3.53 x 247.20	OR 04975				
3.53 x 253.60	OR 041000				
3.53 x 266.27	OR 041050				
3.53 x 278.99	OR 041100				
3.53 x 291.69	OR 041150				
3.53 x 304.39	OR 041200				
3.53 x 329.79	OR 041300				
3.53 x 335.19	OR 041400				
3.53 x 380.59	OR 041500				
3.53 x 405.26	OR 041600				
3.53 x 430.66	OR 041700				
3.53 x 456.06	OR 041800				

Corda . Thickness . Dicke . Grosor

5,34mm

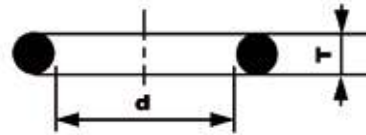

Dimensions (mm) T x d	Model new cross references	Model old cross references	LF Code (EPDM)	LF Code (VITON)	LF Code (SILICONE)
5.34 x 12.07	OR 06050				
5.34 x 13.67	OR 06055				
5.34 x 15.24	OR 06060				
5.34 x 16.62	OR 06065				
5.34 x 18.42	OR 06075				
5.34 x 20.00	OR 06080				
5.34 x 21.59	OR 06085				
5.34 x 23.17	OR 06095				
5.34 x 24.77	OR 06100				
5.34 x 26.34	OR 06105				
5.34 x 27.94	OR 06110				
5.34 x 29.52	OR 06115				
5.34 x 31.12	OR 06125				
5.34 x 32.69	OR 06130				
5.34 x 34.29	OR 06135		1186220		
5.34 x 37.47	OR 06150	OR 0143	3186001	5018795	
5.34 x 40.65	OR 06162	OR 0145	5026454	1786272	
5.34 x 43.82	OR 06175	OR 0148	3186339		5039034
5.34 x 47.00	OR 06187	OR 0151	3186013	5060790	3186313
5.34 x 50.16	OR 06200	OR 0154	3186333		1786094 - 1786275
5.34 x 53.34	OR 06212	OR 0157	1186673	3186241	1786273 - 5023642
5.34 x 56.52	OR 06225	OR 0160	3186014		3186314
5.34 x 59.69	OR 06237	OR 0163	1186932		5038239

Corda . Thickness . Dicke . Grosor

5,34mm

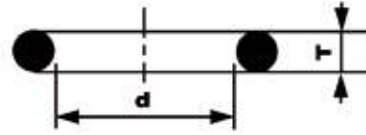

Dimensions (mm) T x d	Model new cross references	Model old cross references	LF Code (EPDM)	LF Code (VITON)	LF Code (SILICONE)
5.34 x 62.87	OR 06250	OR 0166	3186331		
5.34 x 66.04	OR 06262	OR 0169	1186505		
5.34 x 69.22	OR 06275	OR 0172	3160061		
5.34 x 72.39	OR 06287	OR 0175	3786685		
5.34 x 74.63	OR 0178	OR 0178	3186015		1786009
5.34 x 75.57	OR 06300	OR 0179	5039882	1186456	
5.34 x 78.74	OR 06312	OR 0180	3010048		
5.34 x 79.77	OR 0181	OR 0181	5006335		
5.34 x 81.92	OR 06325	OR 0182	3243088		
5.34 x 85.09	OR 06337	OR 0183	3186335		1786246
5.34 x 88.27	OR 06350	OR 0184			
5.34 x 89.69	OR 0185	OR 0185			
5.34 x 91.44	OR 06362	OR 0186			
5.34 x 94.62	OR 06375	OR 0187	1786002		
5.34 x 97.79	OR 06387	OR 0188			
5.34 x 100.00	OR 0189	OR 0189	1186749		
5.34 x 101.00	OR 06400	OR 0190			
5.34 x 104.10	OR 06412	OR 0191			
5.34 x 107.32	OR 06425	OR 0192			
5.34 x 109.50	OR 0193	OR 0193			
5.34 x 110.50	OR 06437	OR 0194	5010476		1186075
5.34 x 113.70	OR 06450	OR 0195			
5.34 x 117.50	OR 0199	OR 0199			
5.34 x 120.70	OR 0201	OR 0201	3160615		
5.34 x 123.80	OR 0203	OR 0203			
5.34 x 127.00	OR 0206	OR 0206			
5.34 x 130.20	OR 0208	OR 0208			
5.34 x 133.40	OR 0210	OR 0210			
5.34 x 136.50	OR 0213	OR 0213			
5.34 x 139.70	OR 0215	OR 0215	5052966		
5.34 x 142.90	OR 0217	OR 0217			
5.34 x 146.10	OR 0219	OR 0219			
5.34 x 149.20	OR 0221	OR 0221			
5.34 x 151.77	OR 06600				
5.34 x 158.12	OR 06625				
5.34 x 164.47	OR 06645				
5.34 x 170.82	OR 06670				
5.34 x 177.17	OR 06700				
5.34 x 183.52	OR 06720				
5.34 x 189.87	OR 06745				
5.34 x 196.22	OR 06775				
5.34 x 202.57	OR 06795				
5.34 x 208.92	OR 06820				
5.34 x 215.27	OR 06850				
5.34 x 221.62	OR 06870				
5.34 x 227.97	OR 06895				
5.34 x 234.32	OR 06920				

Guarnizioni O-Ring
O-Ring Gaskets
O-Ring Dichtungen
Juntas O-Ring

Corda . Thickness . Dicke . Grosor

5,34mm

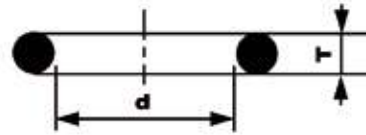

Dimensions (mm) T x d	Model new cross references	Model old cross references	LF Code (EPDM)	LF Code (VITON)	LF Code (SILICONE)
5.34 x 240.66	OR 06945				
5.34 x 247.01	OR 06975				
5.34 x 253.37	OR 06995				
5.34 x 266.07	OR 061050				
5.34 x 278.77	OR 061100				
5.34 x 291.47	OR 061150				
5.34 x 304.16	OR 061200				
5.34 x 329.67	OR 061300				
5.34 x 354.96	OR 061400				
5.34 x 380.37	OR 061500				
5.34 x 405.26	OR 061600				
5.34 x 430.66	OR 061700				
5.34 x 456.06	OR 061800				
5.34 x 481.41	OR 061900				
5.34 x 506.81	OR 062000				
5.34 x 532.20	OR 062100				

Corda . Thickness . Dicke . Grosor

7,00mm

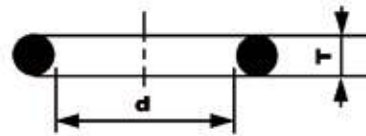

Dimensions (mm) T x d	Model new crossreferences	Model old cross references	LF Code (EPDM)	LF Code (VITON)	LF Code (SILICONE)
7.00 x 113.70	OR 08450	OR 0196			
7.00 x 114.70	OR 0197	OR 0197			
7.00 x 116.80	OR 08462	OR 0198			
7.00 x 120.00	OR 08475	OR 0200			
7.00 x 123.20	OR 08487	OR 0202			1786266
7.00 x 124.60	OR 0204	OR 0204			
7.00 x 126.37	OR 08500	OR 0205		5019666	
7.00 x 129.54	OR 08512	OR 0207			
7.00 x 132.70	OR 08525	OR 0209			
7.00 x 134.50	OR 0211	OR 0211			
7.00 x 135.90	OR 08537	OR 0212	5050109		
7.00 x 139.10	OR 08550	OR 0214			
7.00 x 142.20	OR 08562	OR 0216	2104555		
7.00 x 145.40	OR 08575	OR 0218			
7.00 x 148.60	OR 08587	OR 0220			
7.00 x 151.80	OR 08600	OR 0222			

Corda . Thickness . Dicke . Grosor

7,00mm

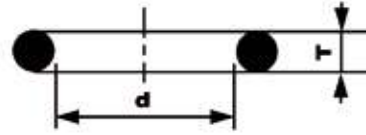

Dimensions (mm) T x d	Model new cross references	Model old cross references	LF Code (EPDM)	LF Code (VITON)	LF Code (SILICONE)
7.00 x 155.60	OR 0223	OR 0223	5006513		
7.00 x 158.10	OR 08625	OR 0224			
7.00 x 159.50	OR 0225	OR 0225			
7.00 x 161.90	OR 0226	OR 0226			
7.00 x 164.50	OR 08650	OR 0227			
7.00 x 166.70	OR 0228	OR 0228			
7.00 x 168.30	OR 0229	OR 0229			
7.00 x 170.82	OR 08675	OR 0230			
7.00 x 174.60	OR 0231	OR 0231			
7.00 x 177.20	OR 08700	OR 0232			
7.00 x 181.00	OR 0233	OR 0233			
7.00 x 183.52	OR 08725	OR 0234	5024838		
7.00 x 187.30	OR 0235	OR 0235			
7.00 x 189.90	OR 08750	OR 0236			
7.00 x 193.70	OR 0237	OR 0237			
7.00 x 196.20	OR 08775	OR 0238			
7.00 x 200.00	OR 0239	OR 0239			
7.00 x 202.57	OR 08800	OR 0240			
7.00 x 208.92	OR 08825	OR 0241			
7.00 x 215.30	OR 08850	OR 0242			
7.00 x 221.60	OR 08875	OR 0243			
7.00 x 227.97	OR 08900	OR 0244			
7.00 x 234.32	OR 08925	OR 0245			
7.00 x 204.67	OR 08950	OR 0246	5026360		5029810
7.00 x 247.00	OR 08975	OR 0247			
7.00 x 253.30	OR 081000	OR 0248			
7.00 x 259.70	OR 081025	OR 0249			
7.00 x 266.07	OR 081050	OR 0250	5034088		
7.00 x 272.40	OR 081075	OR 0251			
7.00 x 278.70	OR 081100	OR 0252			
7.00 x 285.10	OR 081125	OR 0253			
7.00 x 291.50	OR 081150	OR 0254			
7.00 x 297.80	OR 081175	OR 0255	5032360		
7.00 x 304.17	OR 081200	OR 0256			
7.00 x 316.87	OR 081250	OR 0257			
7.00 x 329.57	OR 081300	OR 0258			
7.00 x 342.27	OR 081350	OR 0259			
7.00 x 354.90	OR 081400	OR 0260			
7.00 x 367.67	OR 081450	OR 0261			
7.00 x 380.37	OR 081500	OR 0262			
7.00 x 393.10	OR 081550	OR 0263			
7.00 x 405.26	OR 081600				

Guarnizioni O-Ring
O-Ring Gaskets
O-Ring Dichtungen
Juntas O-Ring

Corda . Thickness . Dicke . Grosor

7,00mm

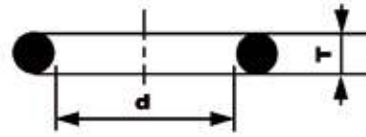

Dimensions (mm) T x d	Model new cross references	Model old cross references	LF Code (EPDM)	LF Code (VITON)	LF Code (SILICONE)
7.00 x 417.96	OR 081650				
7.00 x 430.66	OR 081700				
7.00 x 443.36	OR 081750				
7.00 x 456.10	OR 081800				
7.00 x 481.50	OR 081900				
7.00 x 494.20	OR 081950				
7.00 x 506.90	OR 082000				
7.00 x 532.30	OR 082100				
7.00 x 557.70	OR 082200				
7.00 x 582.70	OR 082300				
7.00 x 608.10	OR 082400				
7.00 x 633.50	OR 082500				
7.00 x 658.90	OR 082600				



Digital catalogues... an exclusive service always available for you



Looking through the interactive catalogues and the search options available in the **Internet shop**, it is now possible to find an item by downloading these catalogues in PDF format

- **Digital catalogues for each brand-manufacturer**
- **Digital catalogues for each product family**

Have you already used this searching function available in our **Internet shop**?

www.lfspareparts724.com
www.lfricambi724.it
www.lfersatzteile724.de
www.lfersatzteile724.ch
www.lfspareparts724.co.uk
www.lfrepuestos-horeca724.es
www.repuestos-hosteleria724.es

www.lfspareparts724.us
www.lfspareparts724.cz
www.lfyedekparca724.com
www.lfspareparts724.ru
www.horeca-zip724.ru
www.epgc.com



Distributing Components, Spare Parts & Accessories
in original quality worldwide



LF SpA HEADQUARTERS

via Voltri, 80 - 47522 Cesena (FC) ITALY
Tel. +39 0547 34 11 11 - Fax +39 0547 34 11 10
www.lfricambi724.it - www.lfricambi724.mobi - info@lfricambi.it
Export Dept.: Tel. +39 0547 34 11 50 - Fax: +39 0547 34 11 55
www.lfspareparts724.com - www.lfspareparts724.mobi
export@lfspareparts.com



EPGC Sas FRANCE

13, Rue des Forts - 59960 Neuville en Ferrain
Tel. +33 (0)3 20 25 06 21
Fax +33 (0)3 20 25 34 12
www.epgc.com
www.epgc724.mobi
epgc@epgc.com



LF GmbH GERMANY

Junkersstrasse, 1 - D-82178 Puchheim - München
Tel. +49 89 89 45 78 66
Fax +49 89 89 45 78 88
www.lfersatzteile724.de
www.lfersatzteile724.mobi
info@lfersatzteile.de



LF China REPUBLIC OF CHINA

Room 403, No.2, Huadu Mansion, Lane 422, Huanghua Rd.
Minhang Dist. - 201103 Shanghai
Tel. +86 (0)21 33 53 66 31
Fax +86 (0)21 33 53 66 32
www.lfspareparts724.com
www.lfspareparts724.mobi
china@lfspareparts.com



OOO LF RUSSIAN FEDERATION

Ul. Anatoliya Zhivova, 8 - office 1 - 123100 Moscow
Tel. +7 499 259 85 75
Fax +7 495 725 26 53
www.lfspareparts724.ru
www.lfspareparts724.mobi
info@lfspareparts.ru



LF Repuestos Horeca S.L.U. SPAIN

Calle Ciudad Real, 10 - 45517 Escalonilla - Toledo
Tel. +34 91 477 91 00
Fax +34 91 477 90 81
www.lfrepuestos-horeca724.es
www.lfrepuestos724.mobi
info@lfrepuestos.es



LF GmbH Verkaufsbüro SWITZERLAND

Sennweidstrasse, 45 - CH-6312 Steinhausen
Tel. +41 (0)41 760 15 80-1
Fax +41 (0)41 760 15 85
www.lfersatzteile724.ch
www.lfersatzteilech724.mobi
info@lfersatzteile.ch



LF Spare Parts Ltd. UNITED KINGDOM

A10a Lakeside Business Park, Broadway Lane
South Cerney, Gloucestershire GL7 5XL
Tel. +44 (0)1285 86 16 25
Fax +44 (0)1285 86 39 49
www.lfspareparts724.co.uk
www.lfspareparts724.mobi
info@lfspareparts.co.uk



AUSTRALIA AND NEW ZEALAND

www.lfspareparts724.com
andrea.calvio@lfspareparts.com



BALKAN COUNTRIES

www.lfspareparts724.com
matija.ramov@lfspareparts.com



BALTIC COUNTRIES

www.lfspareparts724.com
inara.silina@lfspareparts.com



CENTRAL AND EASTERN EUROPE

www.lfspareparts724.cz
jjiri.kremla@lfspareparts.cz



SOUTH KOREA

www.lfspareparts724.com
fabio.doni@lfspareparts.com



TURKEY

www.lfyedekparca724.com
basar.ergun@lfyedekparca.com



USA AND CANADA

www.lfspareparts724.us
sauro.dallaglio@lfspareparts.us